

HOLTOP

WALL MOUNTED ENERGY RECOVERY VENTILATOR

CO2 Sensor Version



Multiple filters
purification of 99%



Indoor&outdoor air
filtration



High efficiency heat
and humidity recovery



Indoor slight positive
pressure



High efficiency
DC fans



Remote control



CO2 monitoring



Easy installation





Delivering a healthy indoor environment

The indoor air can be many times worse than outdoor air. Exchange your indoor air with HOLTOP. In the pursuit of keeping our homes insulated and energy efficient we have also sealed in molds, bacteria, fungus, VOCs, allergens, carbon dioxide and carbon monoxide, all inevitably contributing to the potential for illness.

Between home, work and school, 90% of our lives are lived indoors. That's why the quality of your indoor air is of utmost importance. HOLTOP wall mounted ductless energy recovery ventilator will remove the indoor polluted air with ease and provide a constant supply of clean filtered air, allowing you and your family to live in an ideal indoor environment.



REDUCING THE ELECTRIC BILLS

Struggling with high electricity bills by using the air conditioner and wanna lower energy bill? Most ventilation systems drive up heating and cooling costs while decreasing indoor comfort. Much like venting a room by opening a window, ventilation systems can degrade energy performance because they expel air without capturing the heat. ERV systems conserve energy, lowering electric bills.

The ERV reduces the costs of heating ventilated air in the winter by transferring heat from the warm inside exhaust air to the fresh (but cold) outside supply air. In the summer, the inside air cools the warmer supply air to reduce cooling costs.

The heat from the exhaust air is transferred to the incoming air via a heat exchanger. The heat recovery efficiency is up to 82%. The ERV saves energy up to 30% compared to natural ventilation. This also helps reduce the size of the HVAC equipment needed because it doesn't have to work as hard to heat and cool when the intake air is conditioned by the ERV unit.

Because the ERV transfers some of the moisture from the exhaust air to the usually less humid incoming winter air, the humidity of the house air stays more constant. This also keeps the heat exchanger core warmer, minimizing problems with freezing.

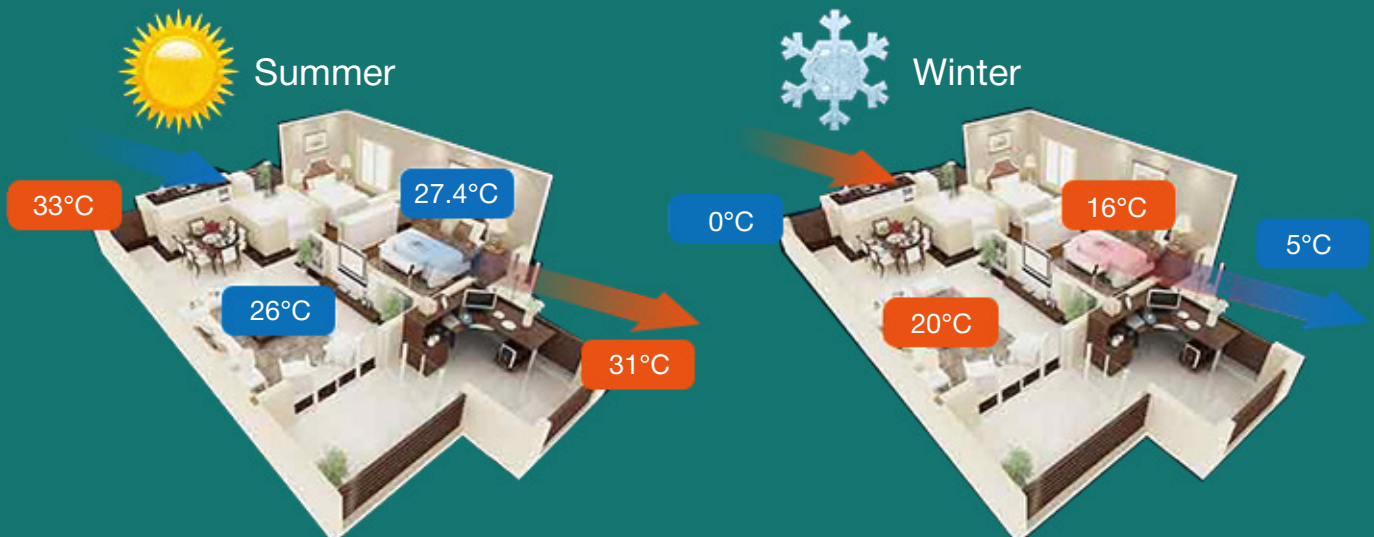

WALL MOUNTED ENERGY RECOVERY VENTILATOR



DUCTLESS TYPE ENERGY RECOVERY VENTILATOR

The single room ERV is designed for both residential and commercial spaces. It's ductless design, suitable for easy and high-efficient ventilation in the new or retrofitting buildings no need to run ducts anywhere in the room.

FEATURES

- Easy installation for ventilation in single room size 15-50m2.
- Heat recovery efficiency up to 82%.
- Brushless DC motor with low energy consumption, 8 speeds.
- Silent operation noise (22.6-37.9dBA).
- Indoor air quality monitor (humidity + temperature + CO2).
- Supply air purification with primary filter+medium filter+HEPA filter(H10) with activated carbon filter as standard, the PM2.5 purification efficiency is up to 99%.
- Thin and light weight and compact size.
- Two kinds of installation to suit room.
- Slight positive ventilation to ensure fresh air won't come through doors or windows without purification.
- Smart phone control Android / IOS.

DESIGN

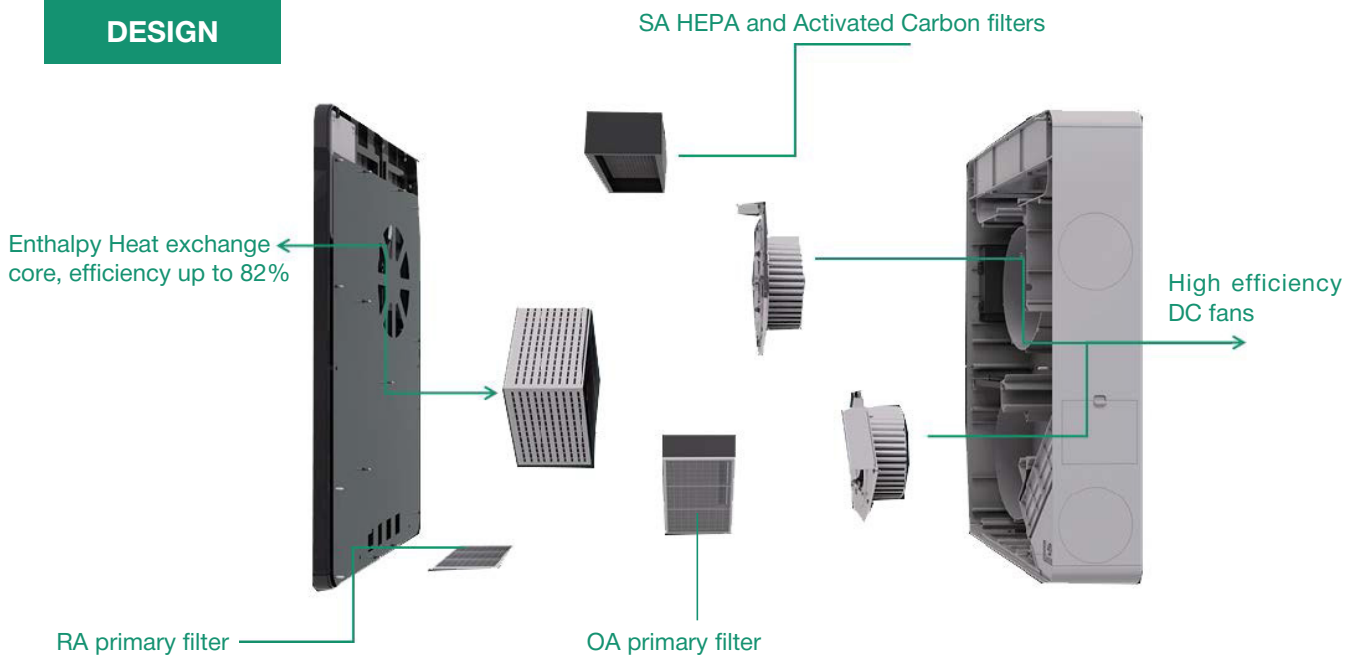

CASING

The casing is integrated with a seamless and leak proof ABS frame made by molding. It has good quality of high strength, light weight, good insulation, smooth surface and easy to clean. The upper panel ensures convenient access to the replacement of HEPA filter and activated carbon filter. The OA primary filter and medium filter are at the side of the ventilator while RA primary filter is at the bottom of the unit. The unit has two inlets and outlet spigot with a diameter of 100mm for fresh air intake and stale air outlet.

AIR FILTRATION

The primary filter, F5 filter, the HEPA H10 filter, and activated carbon filters are included at the supply air side. The purification efficiency of PM2.5 is up to 99%. The primary filter is included in the extract air side. Both primary filters are washable and durable for use for a long time. It can reduce the maintenance costs of the unit.



FANS

The unit takes advantage of using brush less DC motors and 8-speed regulation for supply air and exhaust air. freely adjust the air supply volume slightly larger than the exhaust air volume to form a slight positive pressure in the room to ensure that no pollutants can penetrate into the gaps such as windows and doors. The DC motor has strong vibration resistance with lower noise and smooth operation, good ability and stability.

ENTHALPY HEAT EXCHANGER (heat & humidity recovery)

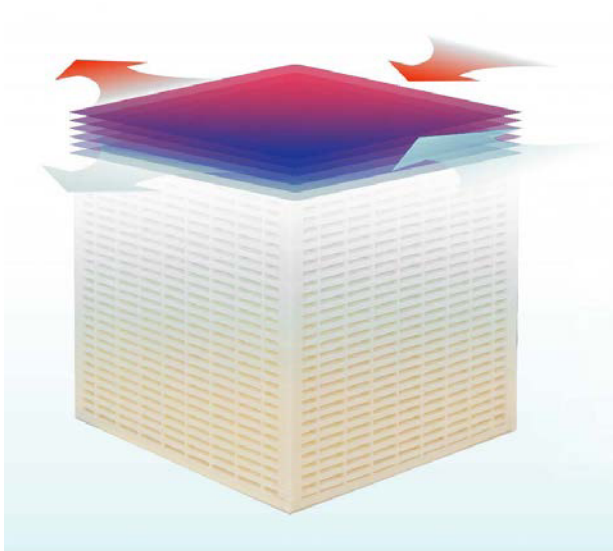

The model ERVQ-B150 unit is equipped with a crossflow heat exchanger with enthalpy membrane. Membrane is made of imported pulp by special processing methods and adding some inorganic materials and fire retardant, to keep the heat exchange paper thin while maintaining high heat transmissibility, anti-tear properties, fireproof and keep the corrugated paper stiff and strong but thin.

Enthalpy heat exchanger was coated with a hygroscopic agent with high absorption and release ability on the surface. The small particle diameter water moisture molecule can pass while the bigger particle diameter like harmful gas or peculiar smell gas molecules can't pass, to make sure heat exchanger paper have strong penetrability, good selective ability and air tightness.

FUNCTIONING



CONTROL PANEL



1. The upper left corner is the WIFI connection status.
2. The upper right corner of the screen is the clock or timing status.
3. The upper central part of the screen is the current indoor CO2 concentration / PM2.5 value.
4. The lower left side of the screen is the current room temperature and humidity values.
5. The lower right side of the screen is the current operation speed of the device.
6. At the bottom of the screen are three adjustable buttons.
7. "Auto" "Manual" "Timing" "Sleep" "PURE-L" "PURE-M" and "PURE-H" are mode indication.

CONTROL

- The unit is equipped with a control panel
- The remote control is supplied as standard
- Wi-Fi communication
- Controlled by Android or iOS smartphone or tablet



APP CONTROL

- Speed change over
- Filter replacement indication
- Alarm indication
- Speed setting
- Timer
- Weekly schedule
- Group control
- Scene control

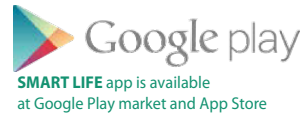

SCENE CONTROL

User can create the scene according to the weather changes, schedule or the device status changes. For example, when the weather shows the outdoor relative humidity is higher than 85%, user can set the ventilator to stop running, to prevent the outdoor humidity coming inside. On the other hand, users can add the devices with Tuya APP to their home screen. For example, they can add all the single room ventilator, exhaust fans or light switches in the APP and control them at their will.

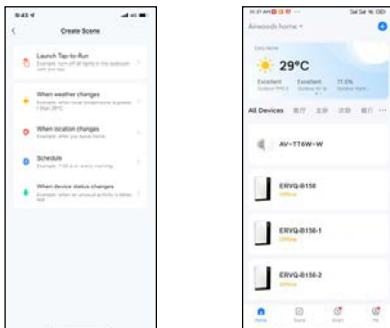

GROUP CONTROL

The ventilator can create group control at the APP, the quantity is not limited. User can control all the ventilator in the group easily.

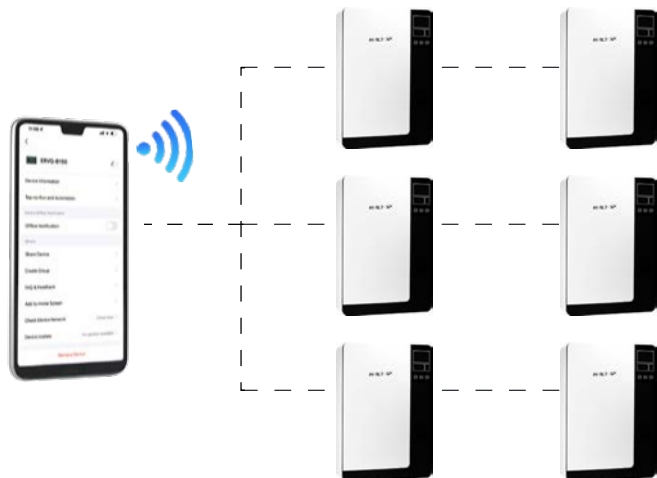

Comprehensive Timely Monitoring, Intelligent Multiple Purification Modes Switch

Original function of “Pure L”“Pure M”“Pure H”, 30mins quick deeply clean



Timely display of CO₂, temperature and humidity

Manual/Auto/Timer mode optional

Remote controller for easy function switch

User manual of remote controller Button function introduction:

- Press “on” to turn on the ventilator.
- Press “off” to turn off the ventilator.
- Press “lock” to turn off the display, Re-press again to turn on the display.
- Press “Hour”, “Hour” part at the top right corner of the ventilator screen starts twinkling, then press “+” to increase me, press “-” to decrease me, repress “Hour” bu on to save me and exit.
- Press “Minute”, “Minute” part at the top right corner of the ventilator screen starts twinkling, then press “+” to increase me, press “-” to decrease me, repress “Minute” bu on to save and exit. Remark: During twinkling, if no opera on in 15s, twinkling ends and save setting automatically.
- Except for the status of me adjustment and being shut down, press “+” to change speed range from small to large, press “-” to change air speed range from large to small. Switching to “Manual” mode, the SA indicator flashes, press “+” or “-” to adjust the SA speed. A er completing the SA speed setting, press “Pure H” switch to the air speed selection of EA (Under this state, the “Pure H” bu on is equivalent to the “Mode” bu on), press “+” or “-” to adjust the air speed, a er completing the EA speed setting, press “Pure H” bu on again can exit the speed setting(or automatically exit without ac on for 15s), the air speed of SA and EA will be saved respectively.
- The function of “Sleep” bu on is similar to “Sleep” bu on on ventilator.
- The function of “Auto” bu on is similar to “Auto” bu on on ventilator.
- Timer: Press “Timer”, timer mode starts, me at the top right corner of the machine screen twinkles. Press “+” to increase me and “-” to decrease me in interval of 30 minutes, the longest timing is 8 hours, default timing is 00:00; Repress “Timer” bu on to save and exit timer setting, top right corner of the ventilator displays current me again.
- The function of “PURE L”, “PURE M”, “PURE H” is similar to that on the ventilator. Remark: During twinkling, if no opera on in 15s, twinkling ends and save setting automatically. A er timer setting finished, if repress “Timer” bu on, top right corner of the display shows remaining me for the timer setting, at this me it is ok to set the timer again. To cancel timer function, set the me to 00:00.

Under mode “Auto”, the ERV will adjust supply air volume according to indoor CO₂ range, corresponding speed as below:

CO ₂ Value	Status	Operational Speed
CO ₂ ≤ 500	Excellent	1
500 < CO ₂ ≤ 650	Good	3
650 < CO ₂ ≤ 800	Gentle Pollution	5
CO ₂ > 800	Serious Pollution	8

Remark: To ensure sufficient indoor fresh air supply, the speed will rise automatically after model “Auto” runs for some time, 5-10 minutes later it will return to previous speed. During this time, the screen shows different speed from above chart.

TECHNICAL DATA

Technical Parameters

Model	ERVQ-B150-1B1							
Speed	1	2	3	4	5	6	7	8
Supply airflow [m3/h]	50	64	78	92	106	120	134	150
Voltage [V/50(60)Hz]								
Max. unit power [W]	12.6	16.9	18.1	2.9	25.2	29.2	34.2	43.8
Max. unit current [A]	0.16	0.18	0.19	0.21	0.24	0.27	0.31	0.37
Sound pressure level at 1.5m distance [dBA]	22.6	25.1	27.7	29.7	31.7	33.1	35.1	37.9
Transported air temperature [°C]	-15~+40							
Casing material	ABS							
Motor type	DC Type							
Filtration efficiency [%]	99% HEPA							
Filtration mode	Pure High, Pure Medium, Pure Low							
Temperature efficiency [%]	82							
Enthalpy efficiency (heating) [%]	58							
Enthalpy efficiency (cooling) [%]	52							
Control	Touch Screen Panel / Remote control							
Air quality display	CO2, Temperature and Relative Humidity							
Operational mode	Manual / Auto / Timer / Sleep							
Suitable room size [m2]	20-45							
Dimension [mm]	450*155*660							
Weight [kg]	10							

Ecodesign Information

Model	ERVQ-B150-1B1					
Specific energy consumption (SEC) [kWh/(m2.a)]	Cold		Average		Warm	
	-88.8	A+	-45.17	A+	-20.14	E
Type of ventilation unit	Bidirectional					
Type of drive installed	Eight speed					
Type of heat recovery system	Recuperative					
Thermal efficiency of heat recovery [%]	82%					
Maximum air flow rate [m3/h]	150					
Power [W]	43.8					
Sound power level [dBA]	37.9					
Reference airflow rate [m3/s]	0.0417					
Reference pressure difference [Pa]	0					
Specific power input (SPI) [W/(m3/h)]	0.292					
Control typology	Local demand control					
Maximum internal leakage rate [%]	3.5					
Maximum external leakage rate [%]	5					
Mixing rate of bidirectional units [%]	20					
Airflow sensitivity at +20Pa and -20Pa	27					
The classification of the indoor /outdoor air tightness [m3/h]	7					
The annual electricity consumption (AEC) [kWh electricity/a]	Cold		Average		Warm	
	0.21		0.21		0.21	
The annual heating saved (AHS) [kWh primary energy/a]	Cold		Average		Warm	
	45.7		89.4		20.7	

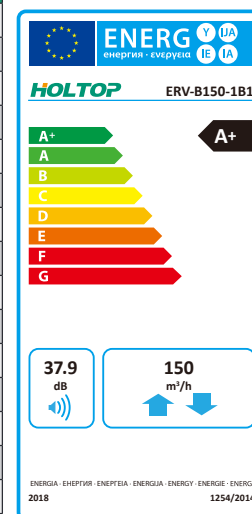

According to regulation EU No 1253/2014 of the European Commission, implementing Directive 2009/125/CE of European Parliament

SOUND TEST



Semi anechoic room

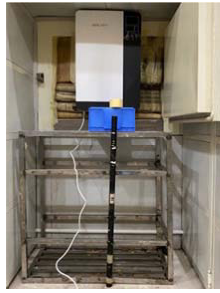

1.5M below ventilator

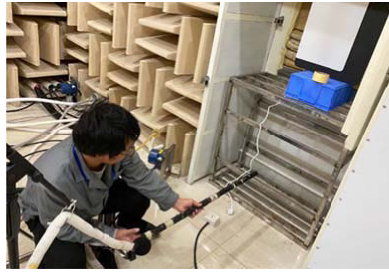

1.5M meters in front of ventilator

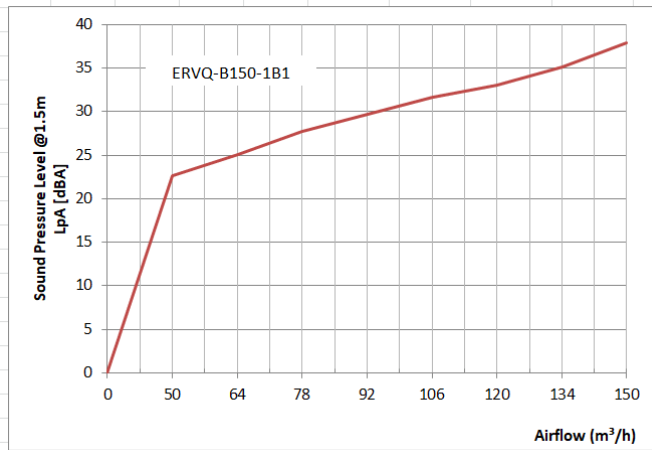

Screenshot from test result

Sleeping mode

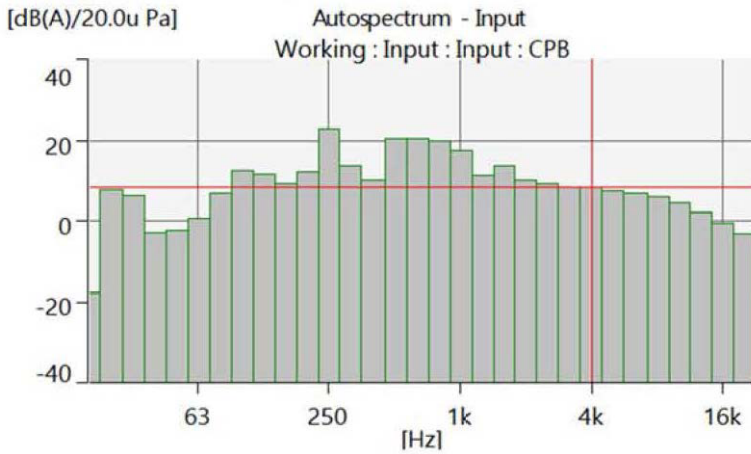

Acoustic Levels

A: 28.4 dB(A)/20.0u Pa
L: 52.7 dB/20.0u Pa

Maximum Value

Y = 22.6 dB(A)/20.0u Pa
X = 250.0 Hz

Cursor Values

Y = 7.75 dB(A)/20.0u Pa

X = 4.000k Hz

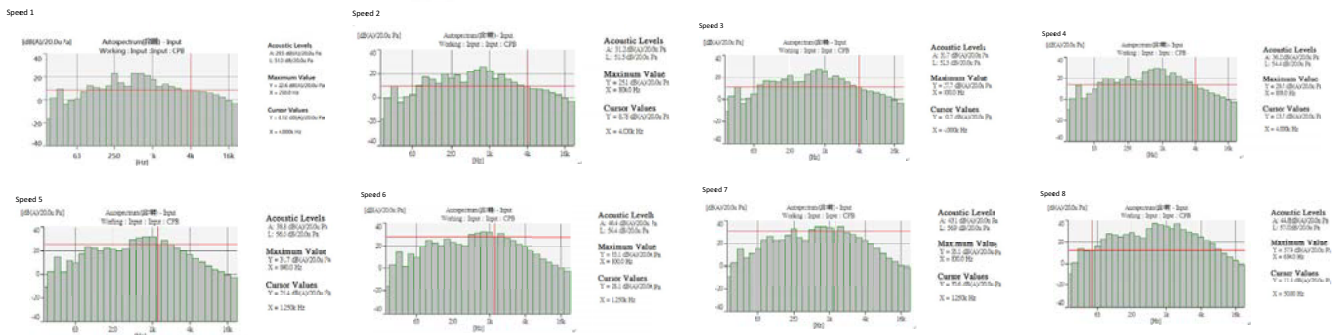



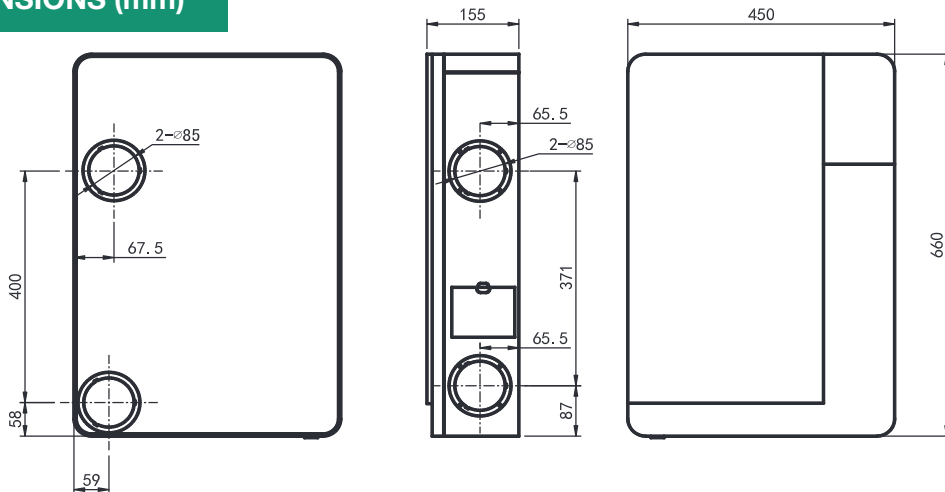

DIMENSIONS (mm)



INSTALLATION ACCESSORIES

The package has included all the accessories needed for the installation. user don't need to prepare extra accessories and save costs.

			
Installation panel 1 pc	Power cable 1 pc	Remote control 1 pc	PVC Ducts 2 pcs
			
OA and EA Side/Back cover 2pcs	Air vent flange 2 pcs	Air inlet grille 1 pc	Air outlet grille 1 pc
			
Rain proof cover 2pcs	Rubber sealing ring 2pcs	Back seal ring 2 pcs	Side sealing ring 2 pcs
			
Knock-on anchor bolt 5 sets	Screws M3x6 and Nut M3 8sets	Tapping screws 4pcs	Back plate insulation foam

INSTALLATION

Installation at the back



Installation at the side

