

LCD CONTROLLER MANUAL

Model: HDK-CK-50A



Contents

1. Panel and Description	3
2. Basic Operation	4
3. Fan Speed Setting	5
4. One-key Fan Boost	6
5. Date and Time Setting	6
6. Bypass Function Setting	7
7. Humidity Control Function	8
8. Anti-frosting Function	8
9. Filter Replacing Alarm Function	8
10. Power Consumption Statistics	9
11. CO2 Control Function	9
12. Electric Heating Control Function	9
13. Parameter Settings	9
14. Error Code Display	11

1. Panel and Description

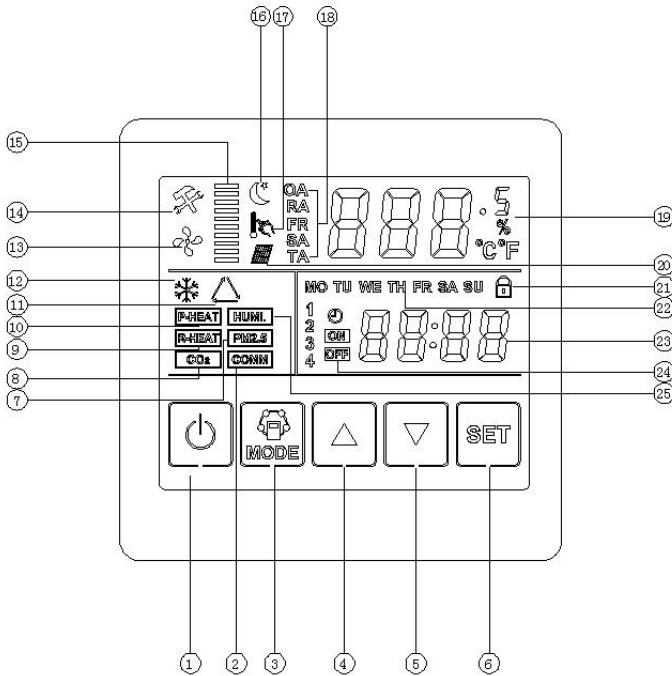

Item	Description
1	Power
2	Communication
3	Mode
4	Up Button
5	Down Button
6	SET Button
7	PM2.5 Symbol
8	CO2 Symbol
9	Heating
10	Pre-Heating
11	Bypass On/Off
12	Defrost On/Off
13	Fan Running
14	Repair
15	Fan Speed
16	Sleep Mode
17	Setting Temperature
18	Temperature Mode
19	Temperature Display
20	Filter Alarm
21	Child safety Lock
22	Week
23	Clock
24	Weekly Timer On/Off
25	Humidity Symbol

2. Basic Operation

1) Power Button

- Press shortly to turn on or turn off the machine.
- Long press this button for more than 6s to lock the screen,and long press the power button for more than 6 seconds to unlock it in the locked screen state. No operation can be performed in the locked screen state.
- When the power is turned off, the display goes off. When turned on again, the device will run according to the status before turned off.

2) Display Mode Selection

- Press the "MODE" button to switch the display status of the device(as shown the figure below).
The set temperature display and the CO2 concentration display can only be displayed after the corresponding function and hardware are turned on.
- Timer on/off mode displays: time, day of the week, timer on, timer off, airflow and room temperature.
- Sleep mode displays: sleep icon, time, day of the week and room temperature.

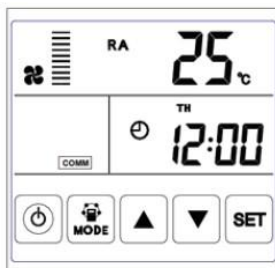

Room temperature

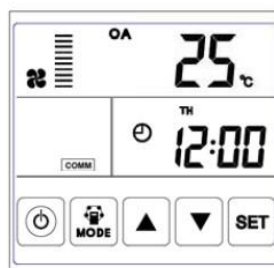

Outdoor air temperature

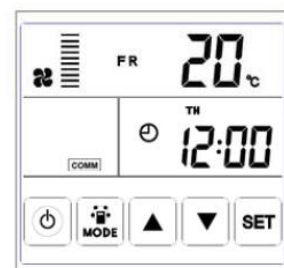

Exhaust air temperature

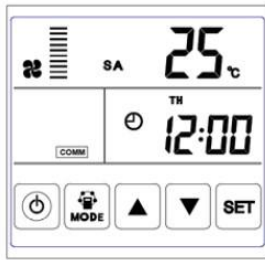

Supply air temperature

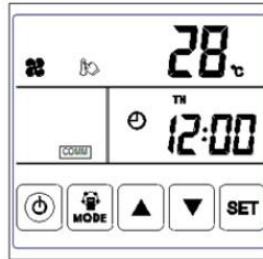

Setting temperature



CO2 concentration

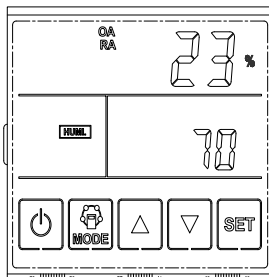

Humidity

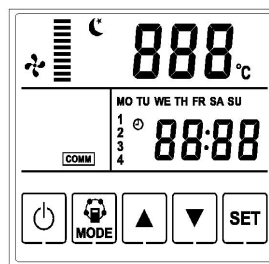



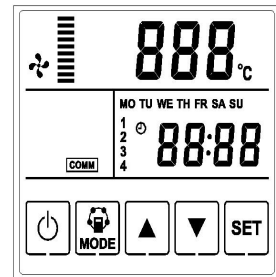

Timer on and off



Sleep mode

3. Fan Speed Setting

① Manual mode fan speed setting

Press the MODE button to switch the supply air temperature (SA) or the exhaust air temperature (FR), click the "△" and "▽" button to adjust the fan speed and the air volume display is: the first speed , the second speed , the third speed , the fourth speed .

② Four periods timer

The 24 hours per day is divided into four periods. The fan speed of the unit can be set at each periods, and the device will run according to the set fan speed till the next period. Under this mode, the fan speed of each period should be set from Monday to Sunday. The time period before the first time node runs according to the fourth time period setting.

Click MODE button to switch the device to the timer on/off mode, press SET

button shortly to start timer setting. After entering the timer setting interface, the “week” flashes, then adjust to the week you need, press SET button shortly again to switch to the hour setting of the first period corresponding to the current week, press SET button shortly again to switch to the minute setting, press SET button shortly again to switch to the fan speed setting. Complete all time settings as per above instructions, press the power button to save and exit after setting.

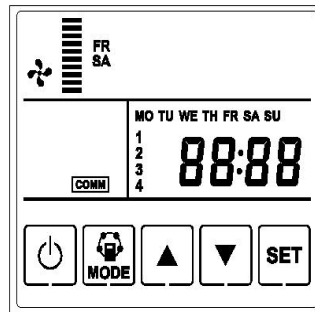

Timer setting

4. One-key Fan Boost

Under any display interface, press " $\triangle + \nabla$ " key at the same time, the equipment will run at boost speed, and return to the previous running state after 60minutes operation. The operation time can be set by the user, and the operation process is described in the following parameter setting. The airflow icon on the LCD controller display starts flashing after turning on the one-key boost speed function.

5. Date and Time Setting

Click MODE button to switch the device to timer on/off mode, long press SET button to start the setting function then adjust the hour by pressing Up and Down button; then short press SET to enter the minute setting, adjust the minute by pressing Up and Down button; short press SET again to set the week, short press MODE or power button to exit after setting completed.

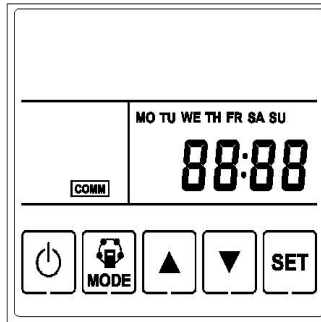

Time setting

6. Bypass Function Setting

The device is shipped from the factory with automatic bypass by default. If user want to manually control the bypass function, they need to turn off the automatic bypass function via parameter NO.02, the operation procedure is described in the parameter setting below.

In the automatic bypass mode, the equipment will automatically control the ON/OFF of bypass according to the fresh air temperature (OA). The opening temperature of the bypass can be set by yourself, and the operation procedure is described in the parameter setting below.

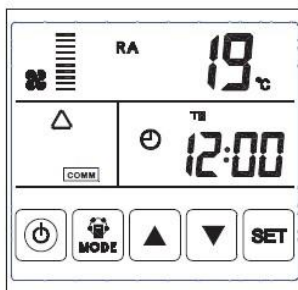

Bypass ON

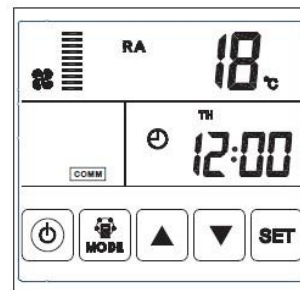

Bypass OFF

After the automatic bypass function is turned off, the manual bypass mode will be activate. At this time, under the display interface of fresh air temperature (OA), long press the "△" button to open the bypass, and the bypass icon will be displayed. Long press the "▽" arrow key to close the bypass, bypass icon will be extinguished.

7. Humidity Control Function

When the equipment is turned on, the equipment will run at a high speed if the indoor humidity value is detected to be higher than the set value. When the humidity value drops below the set value, the equipment will return to the original running state. The humidity setting value can be modified by the user. See the following parameter setting for the operation process.

8. Anti-frosting Function

1) Regular defrosting mode: When the exhaust air temperature is below 5°C (Adjustable at parameter 08) and lasts for 1min, the machine will enter the defrosting mode. The exhaust fan will run at high speed and the supply fan will stop running for 10min (Adjustable at parameter 09). Within 10min, if the exhaust air temperature is higher than 15°C and lasts for 1min, the defrosting mode will exit. The interval time for entering the defrosting model is 30min (Adjustable at parameter 07).

2) Forced defrosting mode: If the fresh air temperature is below -5°C (Adjustable at parameter 22) and lasts for 1min, the machine will enter the defrosting mode. The exhaust fan will run at high speed and the supply fan will stop running for 10min (Adjustable at parameter 09). The interval time for entering the defrosting model is 2 hours (Adjustable at parameter 23).

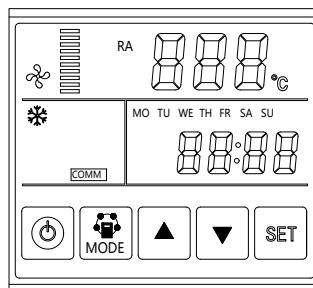

Anti-frosting function activated

9. Filter Replacing Alarm Function

This device has a filter alarm function, which will remind the user to change or clean the filter after 60 days from the date the device is turned on and running. After replacing or cleaning the filter, the user can click the filter alarm button and reset it on the device body control panel, or eliminate the reminder through parameter setting No.16. The operation procedure is described in the

parameter setting below.

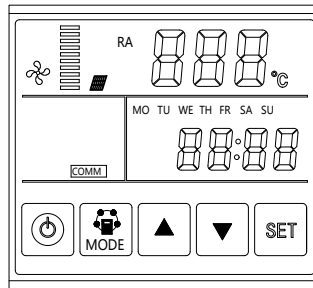

Filter Alarm ON

10. Power Consumption Statistics

This device can approximately count the power consumption of the equipment and electric heating. For the operation process, please refer to the parameter setting below.

11. CO2 Control Function

(CO2 Sensor Needs to be Purchased Separately)

This function needs to be turned on manually, for the operation process, please refer to the parameter setting below.

When the CO2 control function is turned on, and the indoor CO2 concentration is higher than the set value, the supply and exhaust fans will run the maximum airflow for extremely fast ventilation until the CO2 concentration drops below the set value. The CO2 set value can be modified by the user. For the operation process, and the operation process is described in the parameter setting below.

12. Electric Heating Control Function

After connected with the electric heater, user should active the electric heating setting by changing the parameter NO.05 from 0 to 1.

This function is only effective when the electric heating setting function is on, and the device is off by default.

After the electric heating function is ON, click MODE to switch the device to the set temperature interface. Press the "△" or "▽" button to set the electric

heating start temperature. After the setting is done, long press the "MODE" button for 3 seconds to save.

If the supply air temperature is lower than the setting temperature by 5°C and lasts for one minute, the electric heater will be turned on, and the heater icon will be displayed on the touch screen panel. If the supply air temperature is higher than the setting temperature and lasts for one minute, the heater will be turned off, and the heater icon on the screen will disappear.

13. Parameter Settings

Long press the "MODE" button in the power-on state, release the "MODE" button after the buzzer sounds, and enter the parameter setting interface at this time. Short press "SET" button, each time you press it, the parameter value will increase by 1. After selecting the corresponding parameter item according to the following table, press the "△" and "▽" button to adjust the parameter value. After the adjustment is completed, press the "SET" button to confirm and save. After all the parameters are set, short press the power button to exit the setting

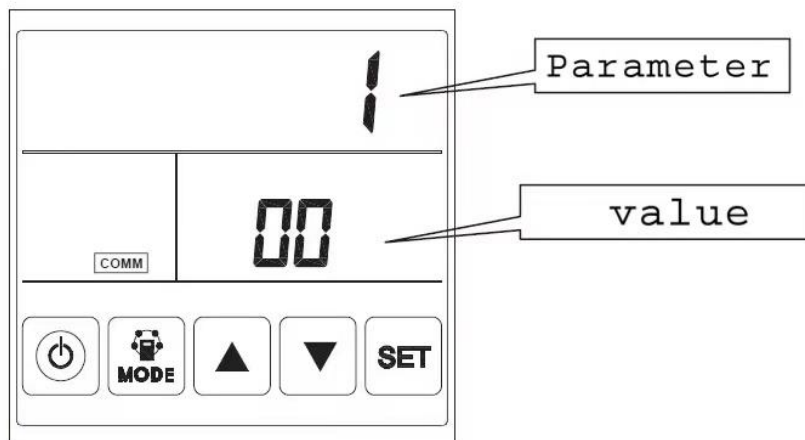

Parameter Setting Instructions

No.	Contents	Range	Default	Unit
01	Power to auto restart	0-invalid 1-valid	1	
02	Auto bypass function	0-invalid 1-valid	1	
03	Bypass opening temperature X	5~30	19	°C
04	Bypass opening temperature range Y	2~15	3	°C
05	Electric heating setting	0-OFF 1-ON	0	

06	Conventional defrosting	0-invalid 1-valid	1	
07	Defrosting interval(regular)	15~99	30	Minute
08	Defrosting entering temperature(regular)	-9~10	5	°C
09	Defrosting duration time	2~20	10	Minute
10	CO ₂ Control function	0-invalid 1-valid	0	
11	CO ₂ setting range	800~2000	1500	PPI
12	Humidity control function	0-invalid 1-valid	1	
13	Humidity setting range	50~100	75	%
14	IP address	1~66	1	
15	ERV model match	Airflow 250 Airflow 350 Airflow 500	500 Resetting at the factory	
16	Filter alarm	0 Filter alarm ON 1 Filter alarm removal	0	
17	Filter alarm setting	0 60 80 100	60	Day
18	One key fan boost time range	0~120	30	Minute
19	Electric heater power setting	500~3000	/	w
20	Device power consumption statistics	0~9999	/	Kw
21	Electric heater power consumption	0~9999	/	Kw
22	Forced defrosting entering temperature	-10~10	-5	°C
23	Forced defrosting time interval	1~3	2	h

14.Error Code Display

Click the MODE button to switch the display state to the room temperature (RA) display, short press the "set" button to display the unit error code, short press the "set" again to switch to display the error information.

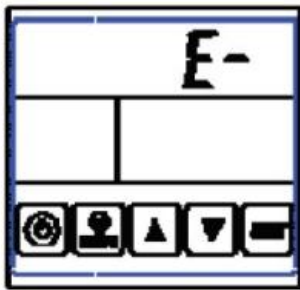

Without error



Error Alarm

Error Code

Code	Error
E1	Fresh air temperature sensor and humidity sensor error
E2	Return air temperature sensor and humidity sensor error
E3	Supply air temperature sensor error
E4	Exhaust air temperature sensor error
E5	CO2 sensor error
E6	Supply fan error
E7	Exhaust fan error
E8	Communication error between control panel and PCB board
E9	Fire alarm