

E-ViPO®

COMFORTABLE INDOOR CLIMATE SOLUTIONS



Fresh Air

Energy Efficiency



150m³/h ~ 800m³/h





FEATURE

- ✓ High Static Pressure, Energy Saving EC Motor
- ✓ High Efficiency Heat Recovery Up to 98%
- ✓ Standard Summer Bypass Integration
- ✓ 15mm-20mm Internal Heat and Sound Insulation
- ✓ Ultra Silent Operation
- ✓ Vertical / Horizontal Installation
- ✓ Service Panels on Both Sides
- ✓ Same Unit for Left or Right Orientation Installation
- ✓ Internal Temperature / Relative Humidity Sensors
- ✓ Optional Electrical Heaters Integration
- ✓ Compact Design / Comfort Design
- ✓ EU1253/2014 ErP2016 ErP2018 EcoDesign Compliant
- ✓ EU1254/2014 Energy Rating SEC Class A+ / A
- ✓ According to EN13141-7



Bypass Auto



5 Speeds



High Efficiency

W OPTIMAL

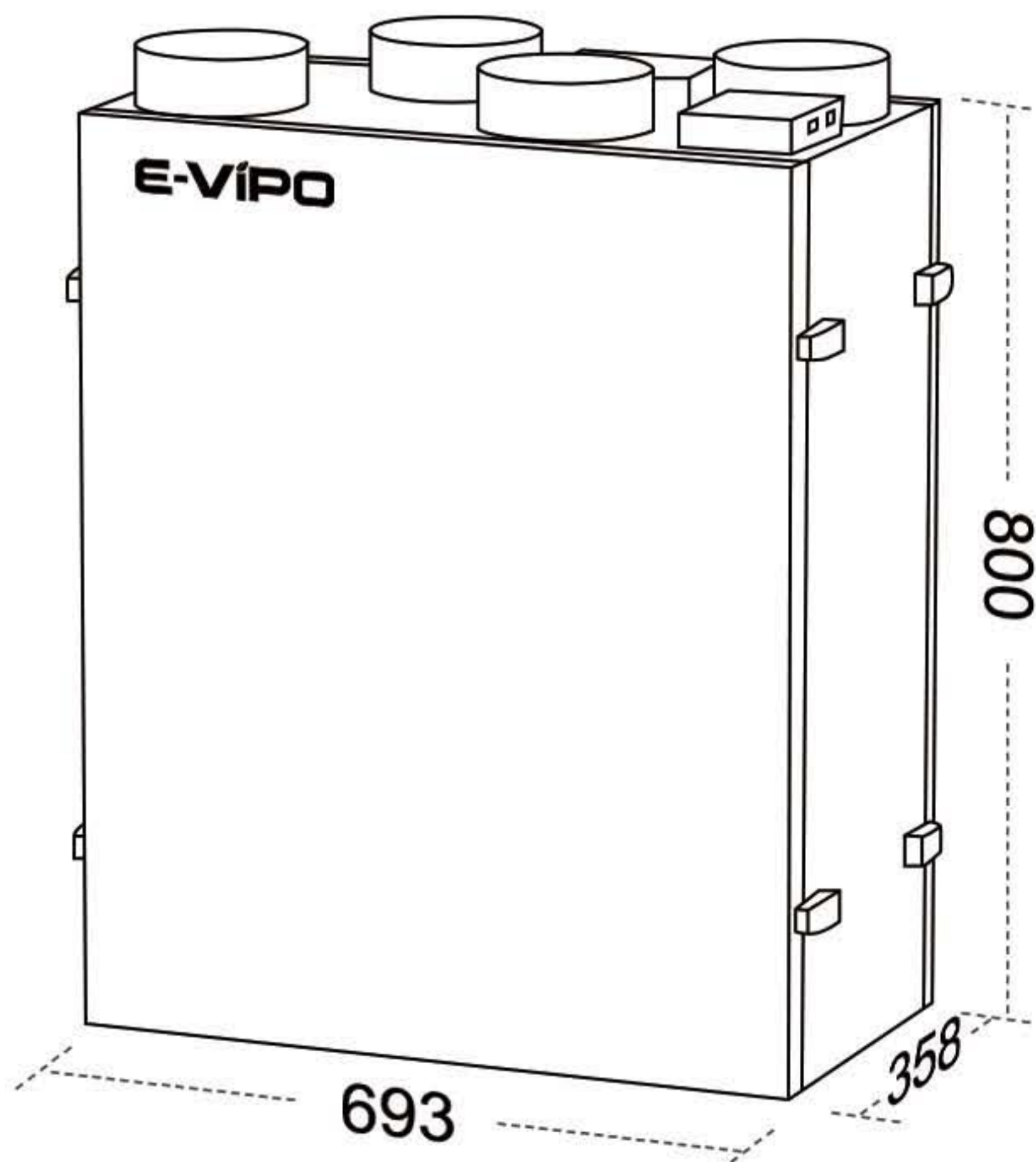

W STANDARD

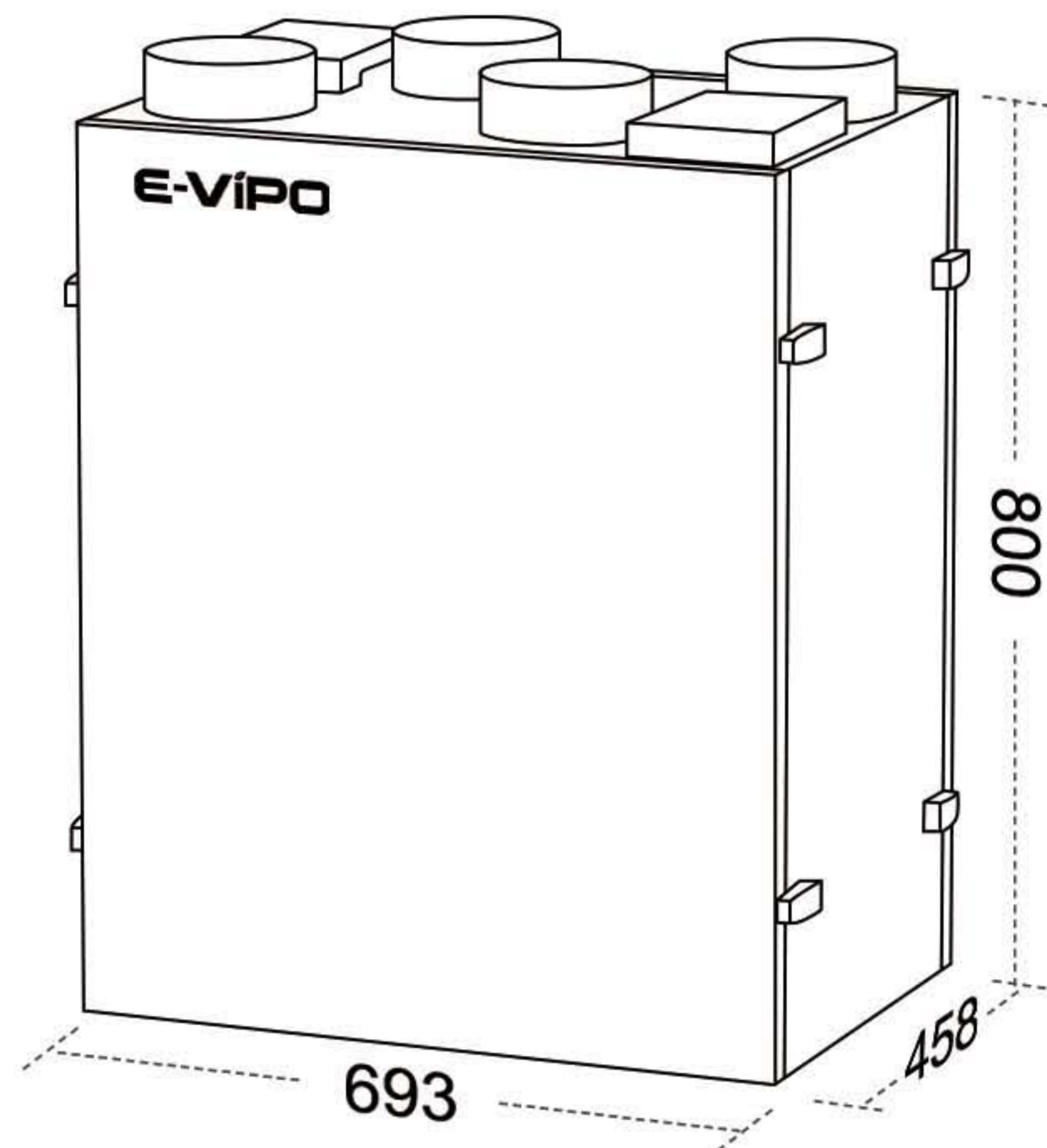

W PREMIUM

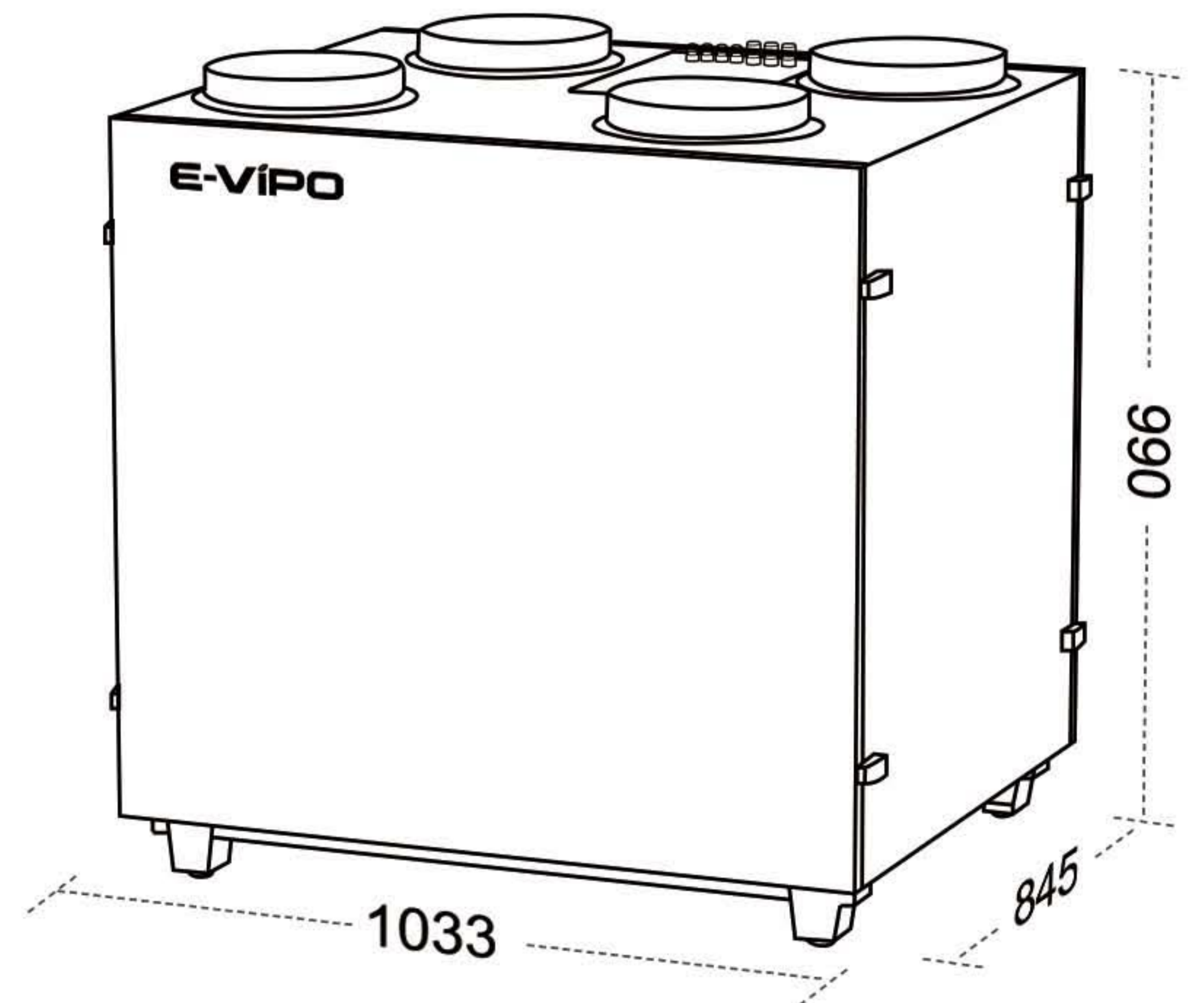

DIMENSION (mm)

COUNTER-FLOW *High Efficiency*

Counter-flow plate heat exchanger (no moving parts), with an optimal distance between layers to ensure a high heat recovery efficiency and a smooth movement of the airflows. Material with Graphene used has a high heat recovery efficiency. The core is washable and durable, anti-mold, anti-viral and anti-bacterial.

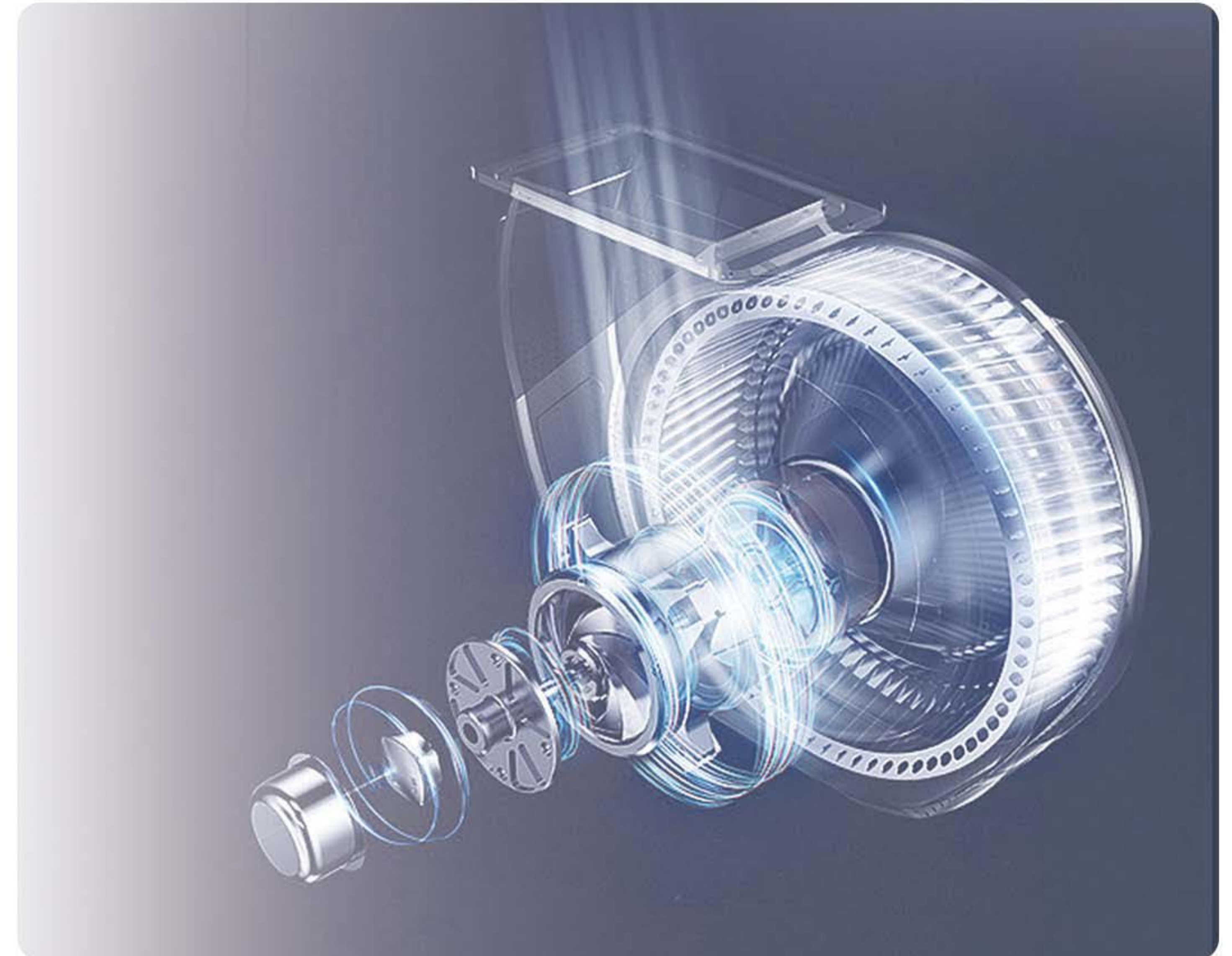

UP TO **98%**



EC Motor

High performance Variable Speed Drive (VSD) EC motor has the features of low power consumption, quiet and high static pressure. This not only reduces the long run electricity cost, but also ensures the air delivering to the room is sufficient after ducting.

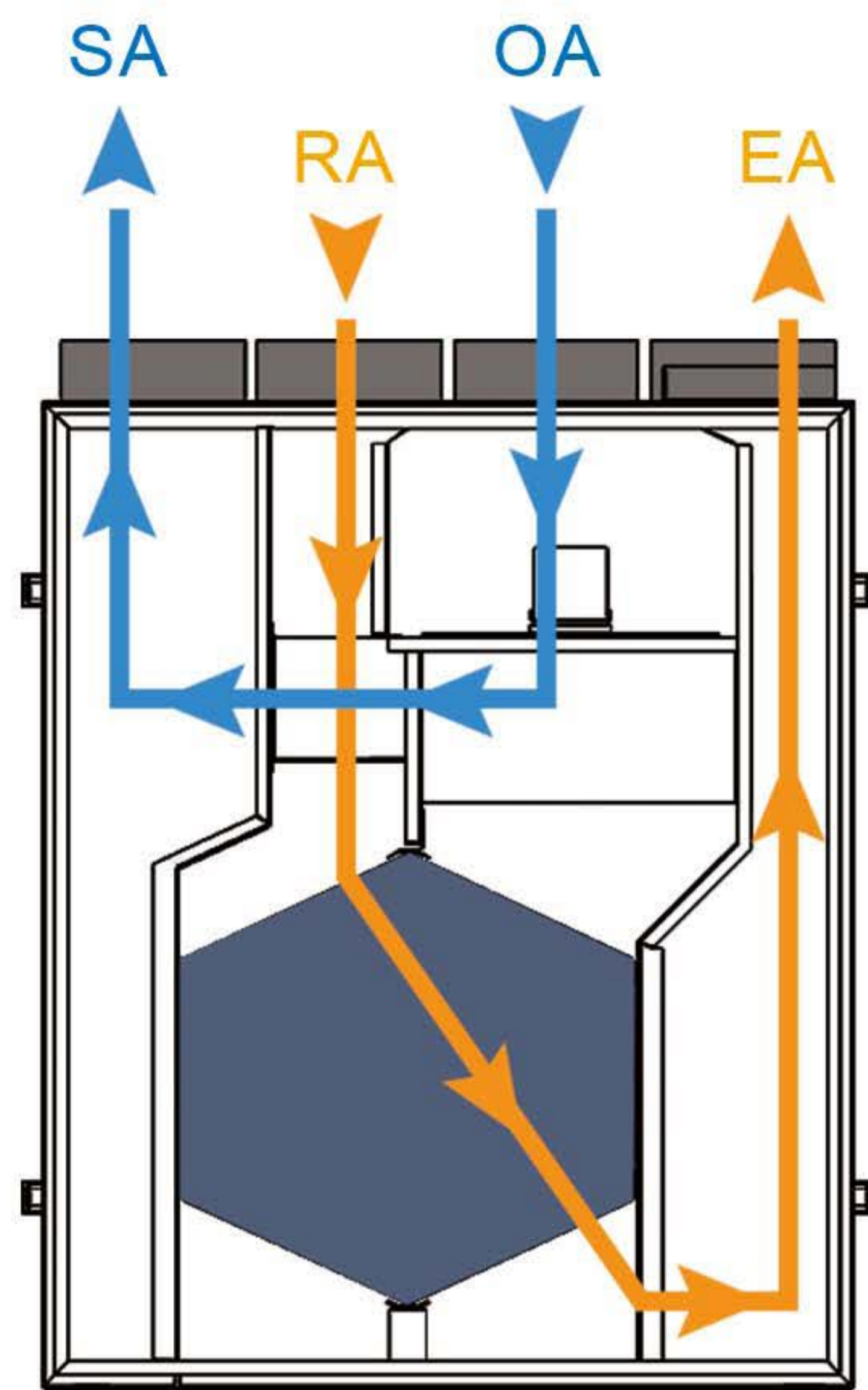

(LEFT Orientation)

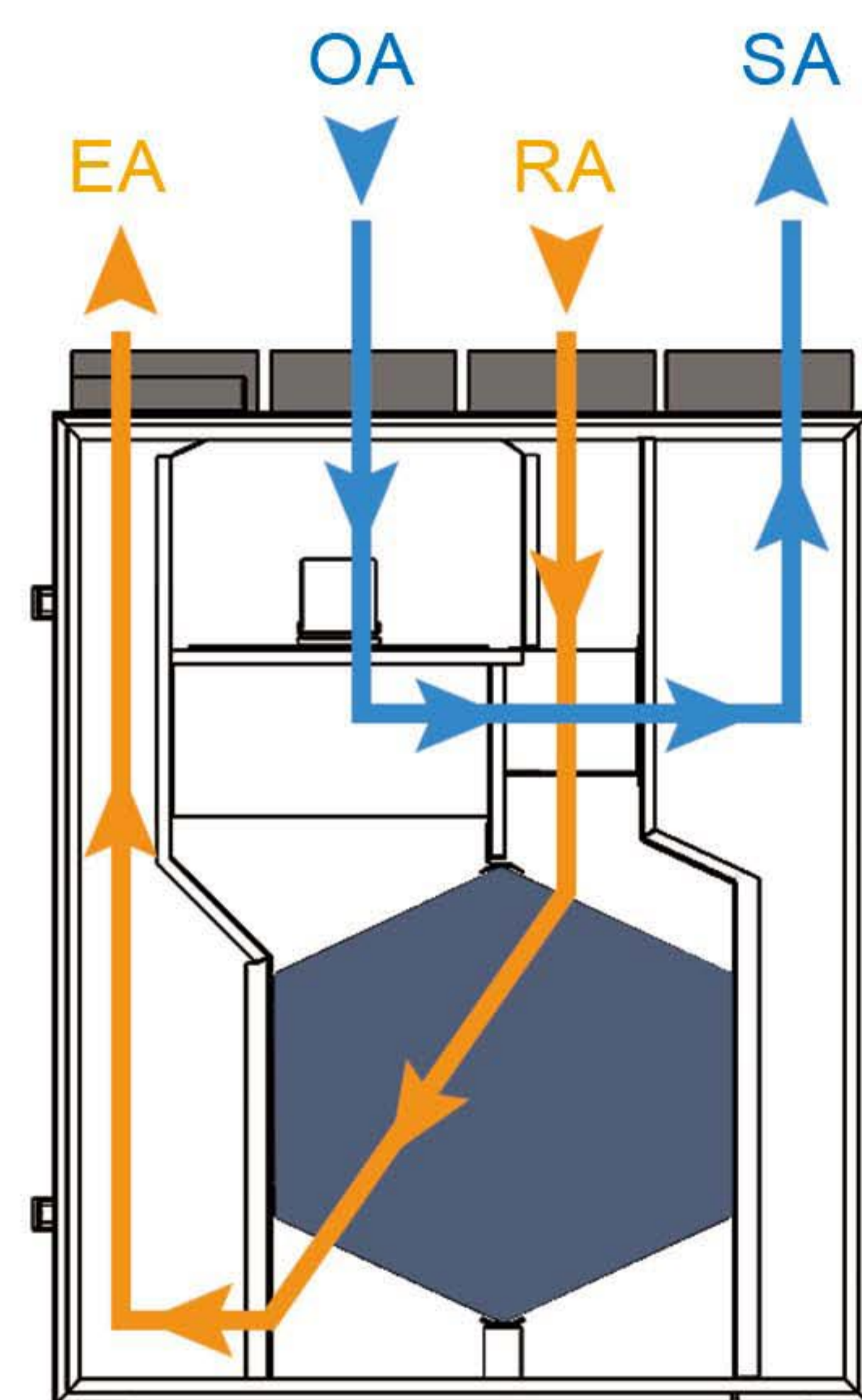

(RIGHT Orientation)

BYPASS Damper

Built-in Bypass damper for summer bypass (free-cooling), without exchanging the heat at the heat exchanger, the fresh air with comfortable temperature level from outdoor can be delivered into the room directly.

High Efficiency

BYPASS

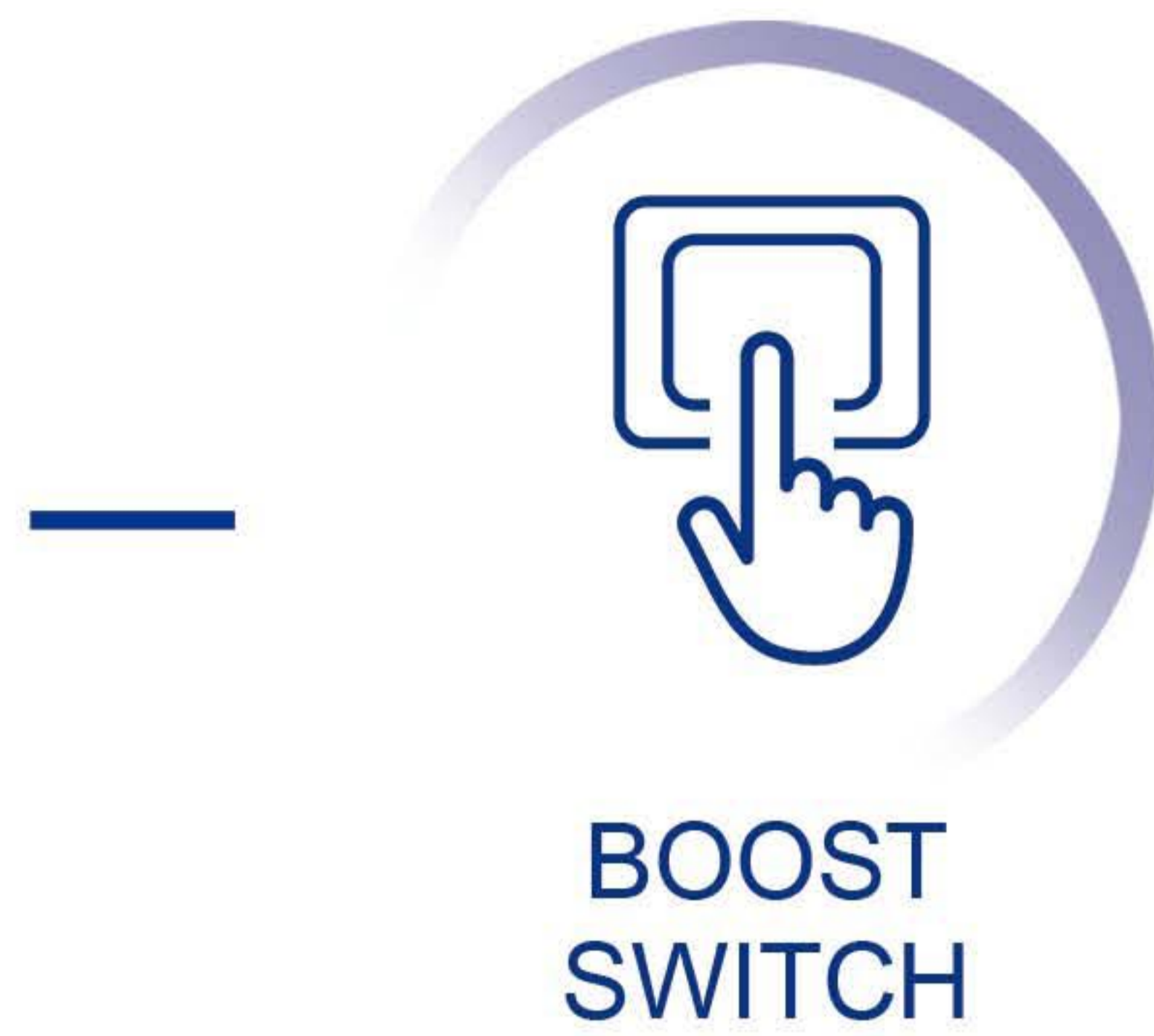
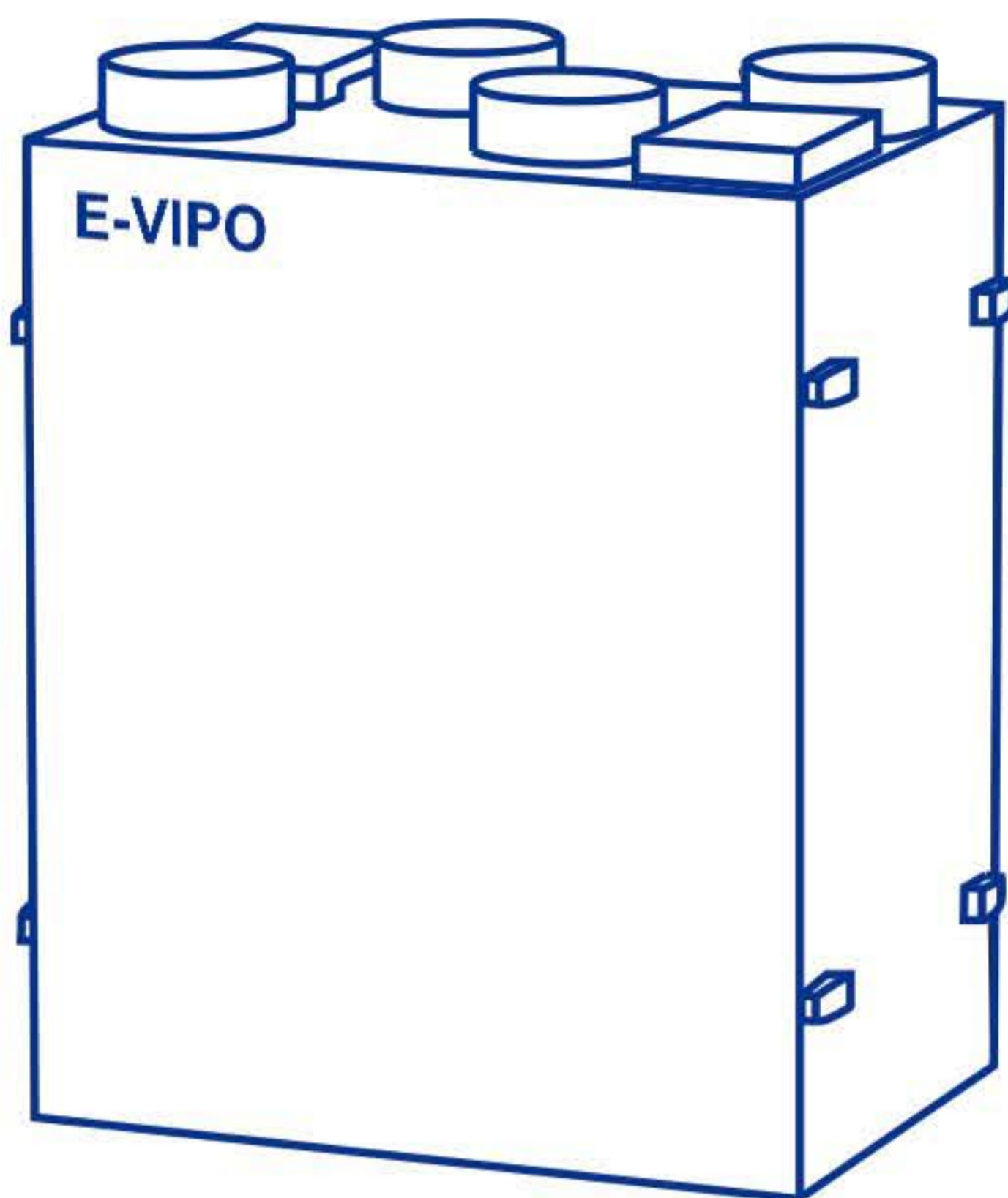

FILTER

Multiple Options

G4 extract filter and G4 supply filter are fitted as standard. F8 supply filter is optional. H11 supply filter is available upon request (H11 filtering efficiency of PM2.5 is >99.9%).

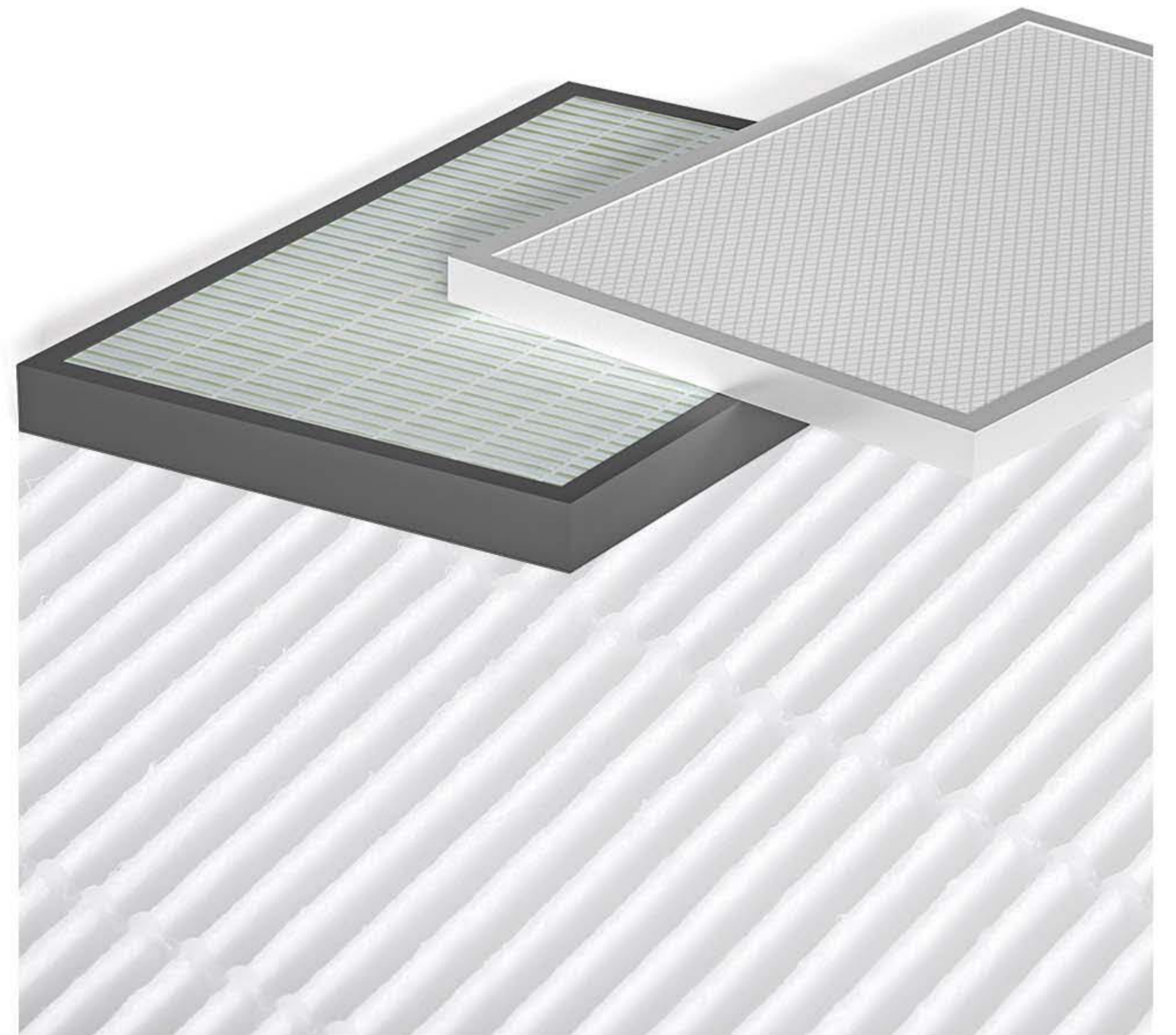

BOOST Function

Rapid Circulation

Boost ventilation is a function that can be triggered when indoor needs a fast circulation of air with outdoor fresh air. When the IAQ is bad, or indoor humidity is high, boost function can be triggered to ensure pollutants are extracted immediately at the highest fan speed. Up to 10 external boost switches can be connected to the control system.

ON-SITE Inversion

Flexible Installation

Service panels are on the both sides, left or right installation can be adjusted at site to meet different installation requirements.

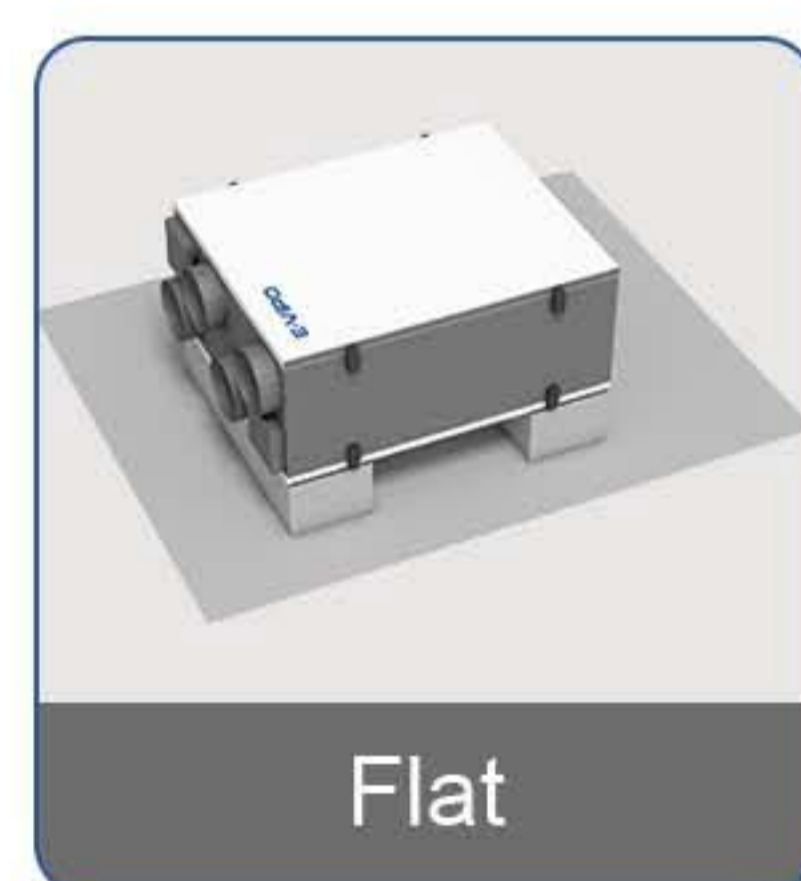

TECHNICAL SPECIFICATION

Model	W150-ERV-B-Z-EC	W190-ERV-B-Z-EC	W240-ERV-B-Z-EC
Fan Motor Type	EC	EC	EC
Max. Airflow [m ³ /h]	150 @ 100Pa	200 @ 100Pa	250 @ 100Pa
Rated Max. Power	230V~50Hz, 60W, 0.5A	230V~50Hz, 85W, 0.7A	230V~50Hz, 126W, 0.8A
Power Input Range	200-240V~, 50/60Hz	200-240V~, 50/60Hz	200-240V~, 50/60Hz
Weight [kg]	45	45	45
Extract Filter	G4	G4	G4
Supply Filter	G4	G4	G4
Supply Filter	F8 (Optional)	F8 (Optional)	F8 (Optional)
Max. Static Pressure [Pa]	285	367	375
Heat Exchanger Type	Counter-flow	Counter-flow	Counter-flow
Heat Recovery Efficiency [%]	89-95	84-95	76-95
Internal Insulation Material	Polyethylene Foam	Polyethylene Foam	Polyethylene Foam
Case Material	Coated Sheet Steel	Coated Sheet Steel	Coated Sheet Steel
Transferred Air Temperature [°C]	(-25 to +50)	(-25 to +50)	(-25 to +50)
Operating Ambient Temperature [°C]	(+5 to +40)	(+5 to +40)	(+5 to +40)
Operating Ambient Relative Humidity [%]	<80	<80	<80
Connected Air Duct Diameter [mm]	150	150	150

* A 10% reduction of supply airflow may occur when Supply Filter F8 applied

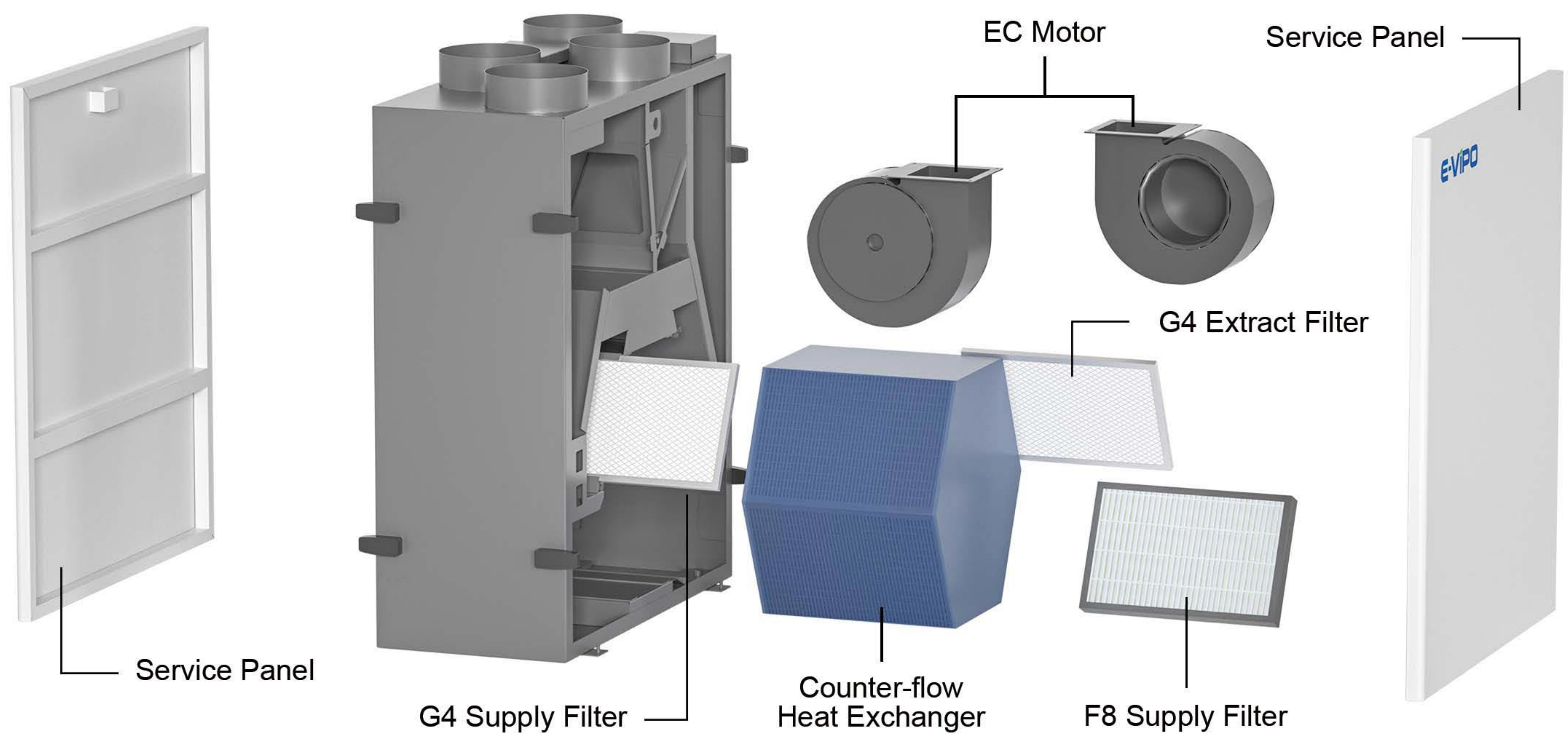

TECHNICAL SPECIFICATION

Model	W200-ERV-B-Z-EC	W250-ERV-B-Z-EC	W300-ERV-B-Z-EC	W350-ERV-B-Z-EC
Fan Motor Type	EC	EC	EC	EC
Max. Airflow [m ³ /h]	200 @ 100Pa	250 @ 100Pa	300 @ 100Pa	350 @ 100Pa
Rated Max. Power	230V~50Hz, 76W, 0.6A	230V~50Hz, 113W, 0.8A	230V~50Hz, 165W, 1A	230V~50Hz, 196W, 1.2A
Power Input Range	200-240V~, 50/60Hz	200-240V~, 50/60Hz	200-240V~, 50/60Hz	200-240V~, 50/60Hz
Weight [kg]	55	55	55	55
Extract Filter	G4	G4	G4	G4
Supply Filter	G4	G4	G4	G4
Supply Filter	F8 (Optional)	F8 (Optional)	F8 (Optional)	F8 (Optional)
Max. Static Pressure [Pa]	378	445	450	450
Heat Exchanger Type	Counter-flow	Counter-flow	Counter-flow	Counter-flow
Heat Recovery Efficiency [%]	86-95	83-95	81-95	78-95
Internal Insulation Material	Polyethylene Foam	Polyethylene Foam	Polyethylene Foam	Polyethylene Foam
Case Material	Coated Sheet Steel	Coated Sheet Steel	Coated sheet Steel	Coated Sheet Steel
Transferred Air Temperature [°C]	(-25 to +50)	(-25 to +50)	(-25 to +50)	(-25 to +50)
Operating Ambient Temperature [°C]	(+5 to +40)	(+5 to +40)	(+5 to +40)	(+5 to +40)
Operating Ambient Relative Humidity [%]	<80	<80	<80	<80
Connected Air Duct Diameter [mm]	150	150	150	150

* A 10% reduction of supply airflow may occur when Supply Filter F8 applied

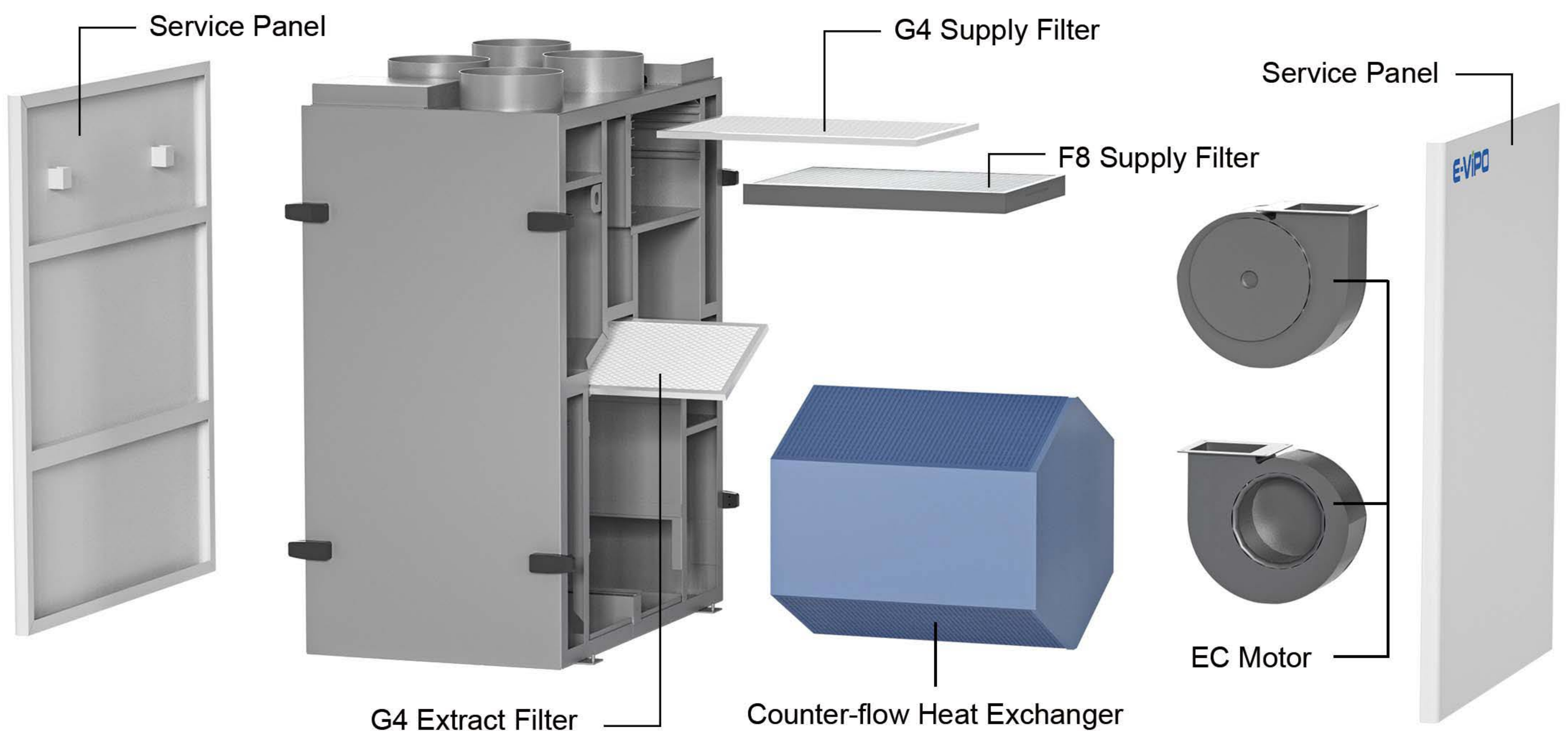

TECHNICAL SPECIFICATION

Model	W600-ERV-B-Z-EC	W700-ERV-B-Z-EC	W800-ERV-B-Z-EC
Fan Motor Type	EC	EC	EC
Max. Airflow [m ³ /h]	600 @ 100Pa	700 @ 100Pa	800 @ 100Pa
Rated Max. Power	230V~50Hz, 300W, 1.9A	230V~50Hz, 330W, 2.4A	230V~50Hz, 420W, 2.7A
Power Input Range	200-240V~, 50/60Hz	200-240V~, 50/60Hz	200-240V~, 50/60Hz
Weight [kg]	120	120	120
Extract Filter	G4	G4	G4
Supply Filter	G4	G4	G4
Supply Filter	F8 (Optional)	F8 (Optional)	F8 (Optional)
Max. Static Pressure [Pa]	250	310	430
Heat Exchanger Type	Counter-flow	Counter-flow	Counter-flow
Heat Recovery Efficiency [%]	94-98	90-98	86-98
Internal Insulation Material	Polyethylene Foam	Polyethylene Foam	Polyethylene Foam
Case Material	Coated Sheet Steel	Coated Sheet Steel	Coated Sheet Steel
Transferred Air Temperature [°C]	(-25 to +50)	(-25 to +50)	(-25 to +50)
Operating Ambient Temperature [°C]	(+5 to +40)	(+5 to +40)	(+5 to +40)
Operating Ambient Relative Humidity [%]	<80	<80	<80
Connected Air Duct Diameter [mm]	250	250	250

* A 10% reduction of supply airflow may occur when Supply Filter F8 applied

Easy Duct Connection

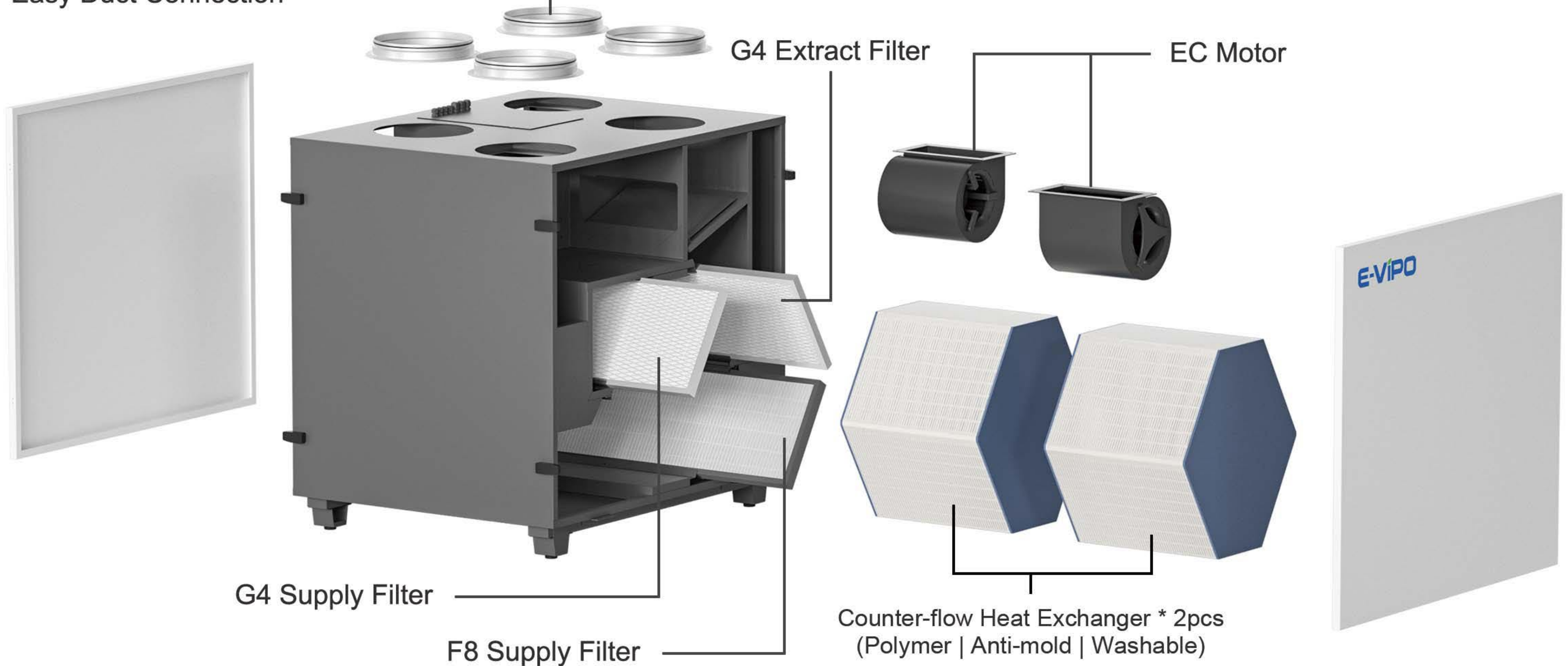

VK8 CONTROL SYSTEM

- ✓ Comprehensive Control System
- ✓ HD 7" Color Touchscreen with Real-time IAQ Display
- ✓ Variable Speed Local Demand Control
- ✓ Modbus RS485 Smart Home Connection
- ✓ IAQ Sensors CO₂ / PM2.5 / VOCs / TEMP / RH
- ✓ Weekly Scheduled Operation
- ✓ Optional Fans Separately Control
- ✓ Multiple External CO₂ / RH / TEMP Sensors Connection
- ✓ Multiple External Boost Switches Connection
- ✓ Bypass / Defrost / IAQ Automation
- ✓ APP Remote Control Available
- ✓ Filter Countdown / Replacement Notification
- ✓ Complete Settings on Control Panel



Bypass Auto



Defrost Auto



RH Control Auto



CO₂ Control Auto



Weekly Timer



Boost Function



Independent Fan Control



5 Speeds



Filter Notification



Remote Control



VK2 CONTROL SYSTEM

- ✓ 3.5" Display & Touchscreen
- ✓ iOS & Android APP
- ✓ Independent Fan Adjustment
- ✓ Filter Management with Filter Timer & Notification
- ✓ Week Scheduled Operation
- ✓ Boost Ventilation Function



5 Speeds



Weekly Timer



Remote Control



Filter Notification

TECHNICAL SPECIFICATION

Model	VK8	VK2
Touchscreen	7" HD (Color)	3.5"
Mode	AUTO / Manual / Sleep	Manual
Fan Speeds	5-Speeds	5-Speeds
Bypass Control	AUTO / Manual	Manual
Boost Function	✓	✓
Built-in CO ₂ Sensor	✓	—
Built-in TEMP Sensor	✓	✓
Built-in RH Sensor	✓	—
Built-in PM2.5 Sensor	✓	—
Built-in VOCs Sensor	✓	—
Defrosting	✓	✓
WiFi & APP	✓	✓
Timer Control	✓	✓
IAQ Indication	✓	—
Filter Notification	✓	✓
RS485 (Smart Home)	✓	—
Bluetooth	✓	✓
External CO ₂ Sensor	× 8 Pcs Max.	—
External RH Sensor	× 8 Pcs Max.	—
External Boost Switch	× 10 Pcs Max.	✓
External Air Damper	✓	✓
External Heater	✓	✓

VK8 Control System

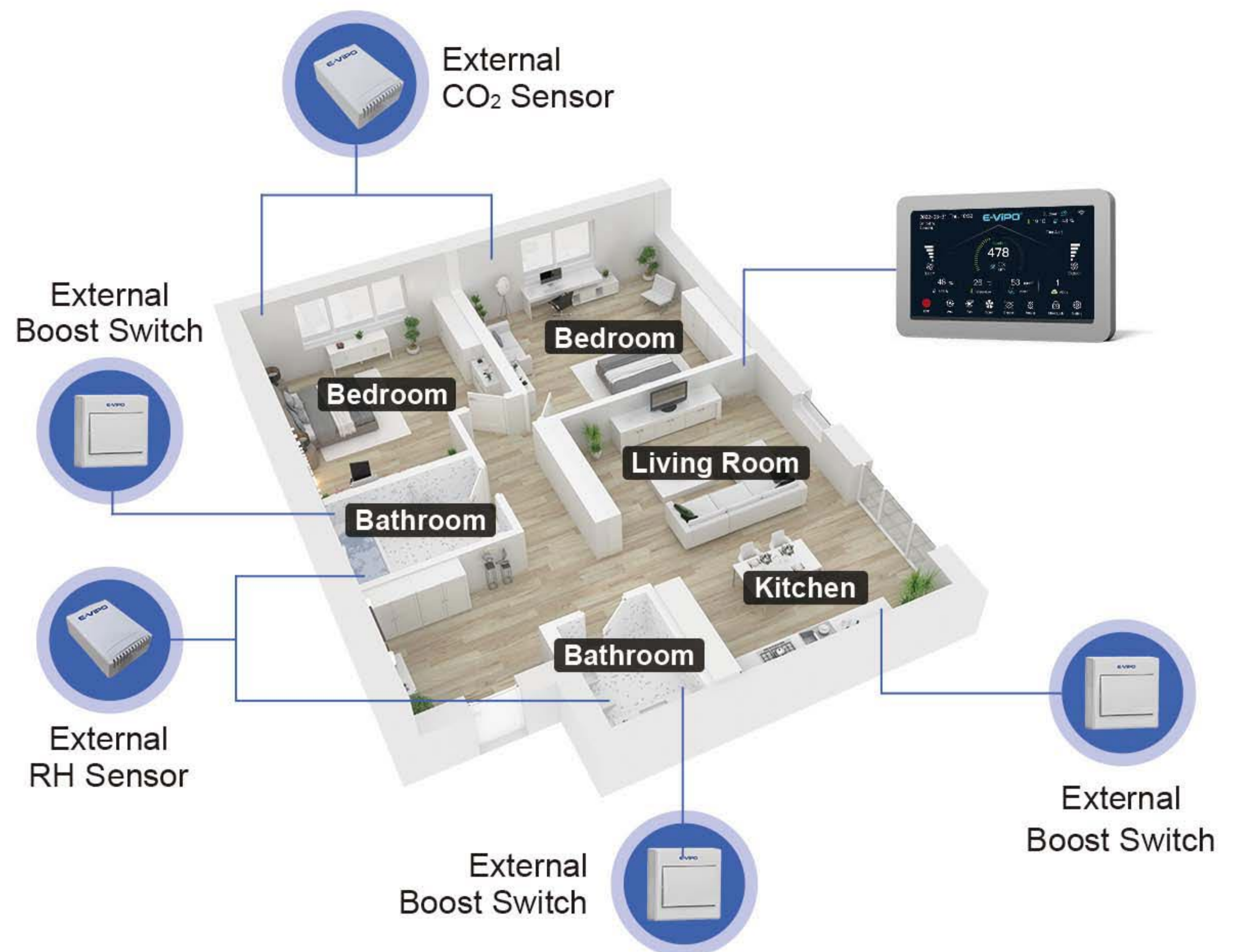

VK2 Control System



MODEL: W150-ERV-B-Z-EC

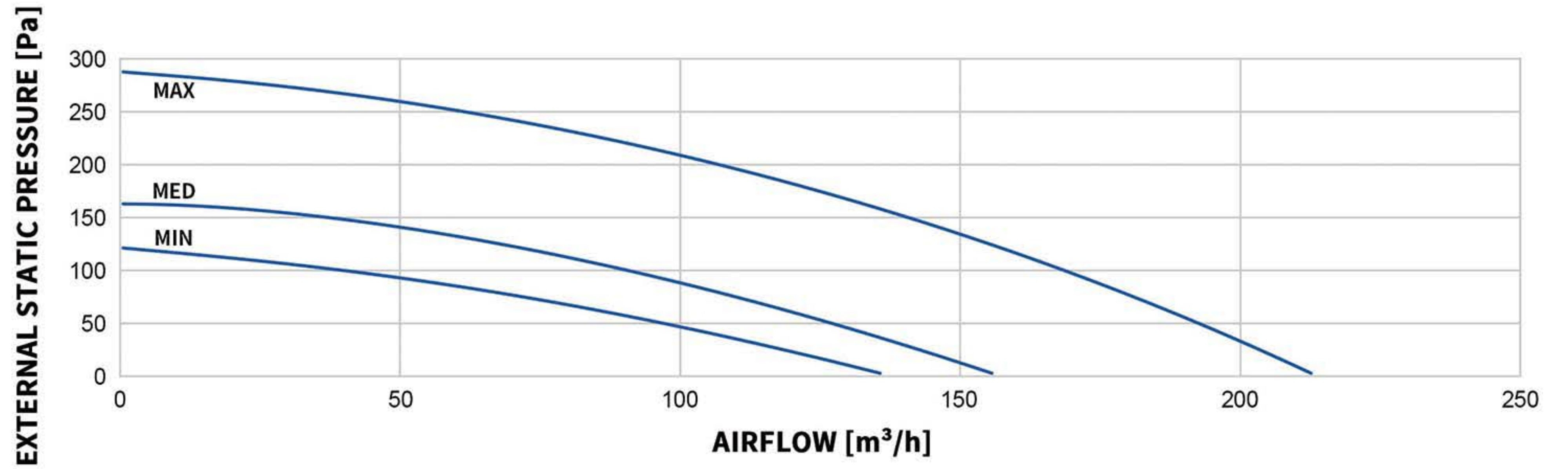
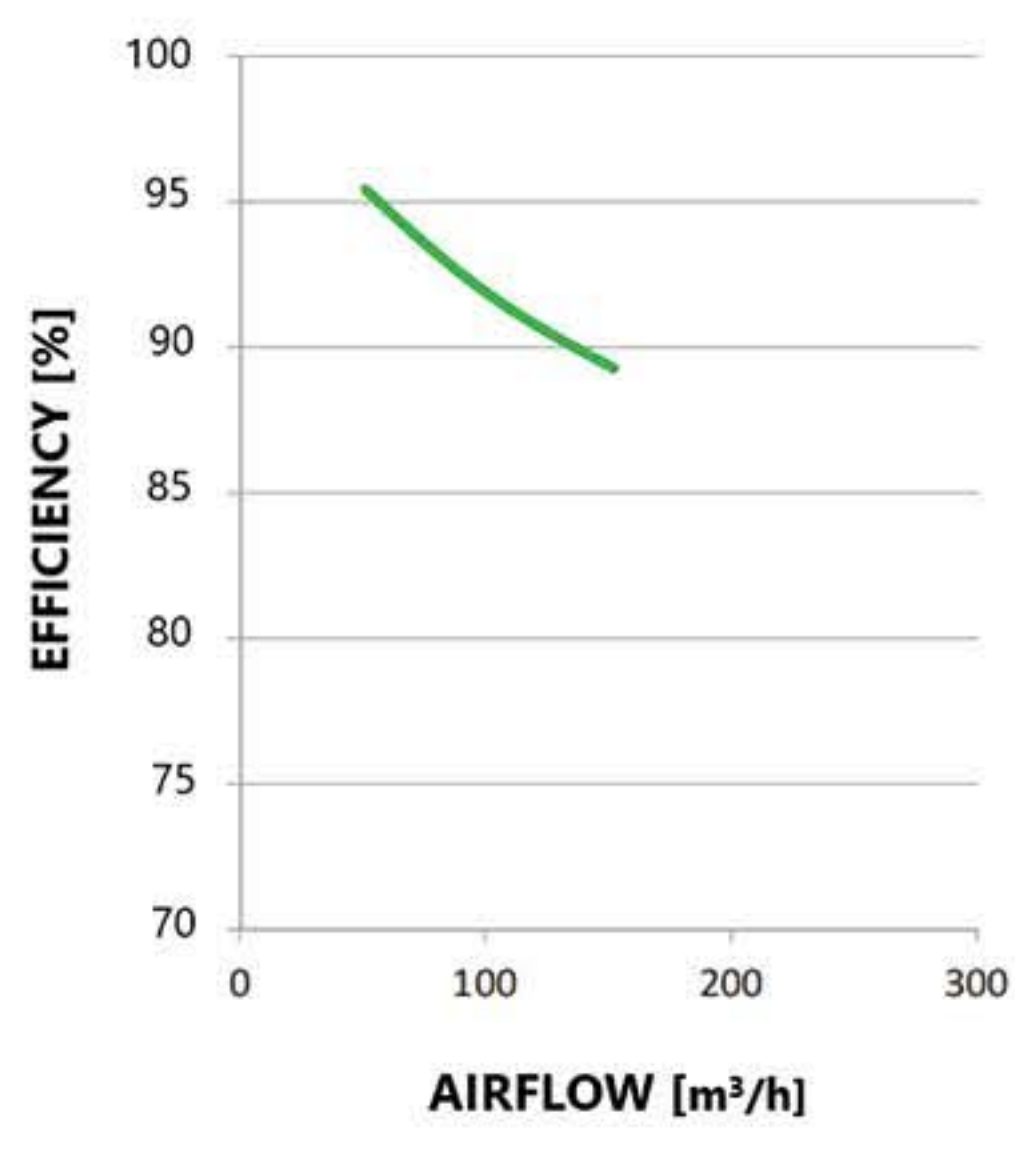

MODEL: W190-ERV-B-Z-EC

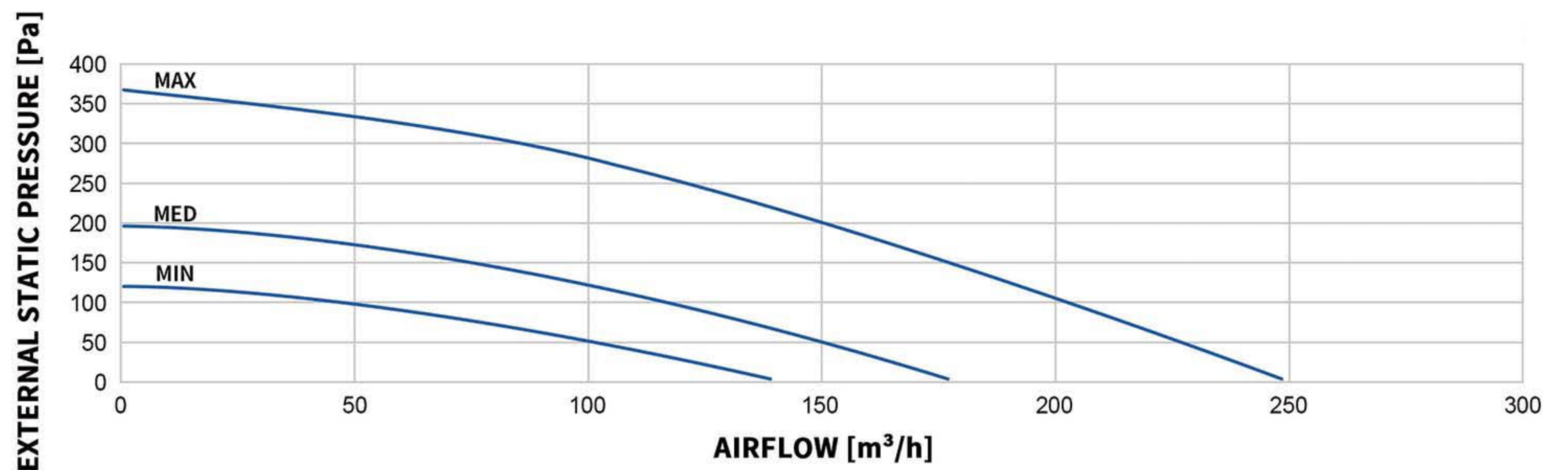
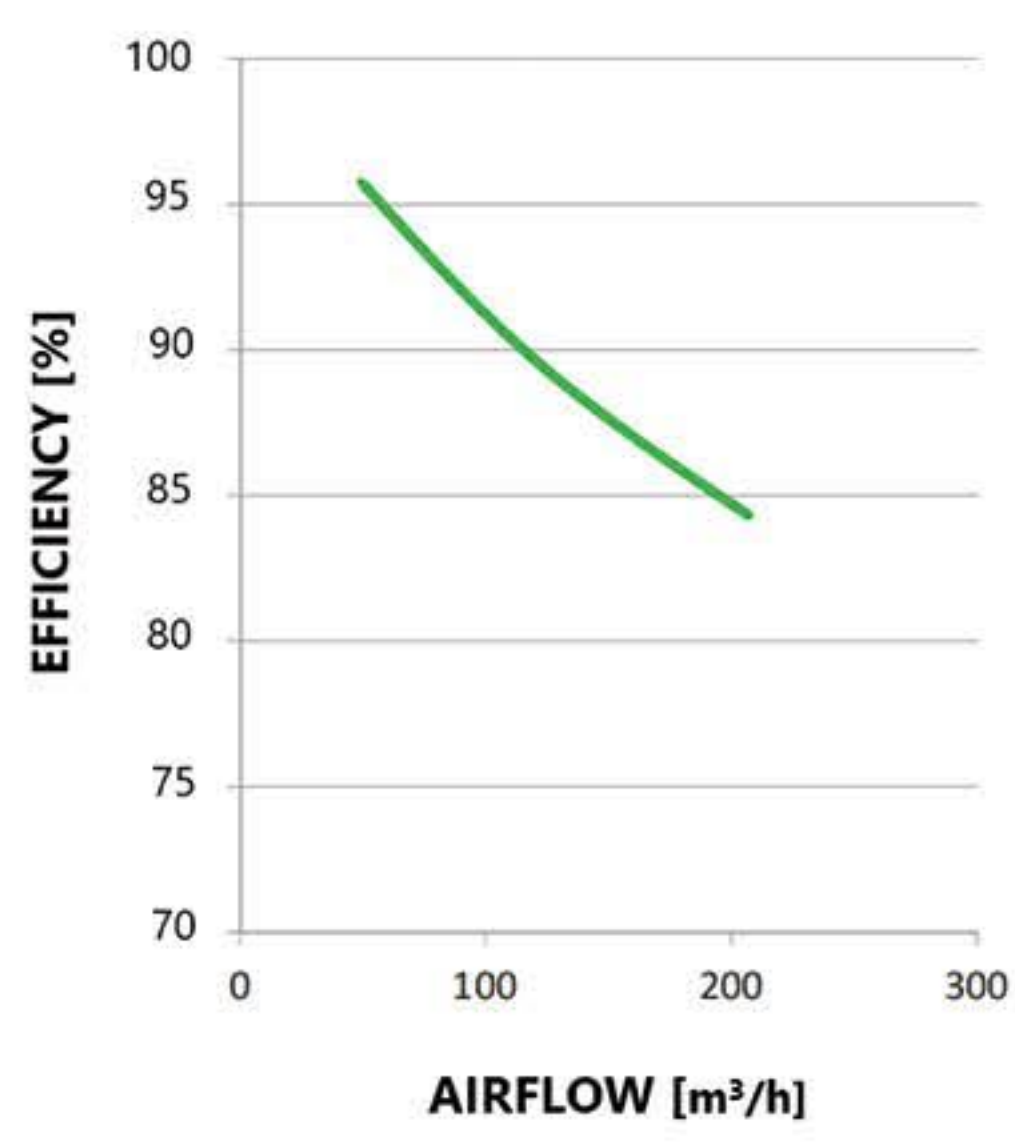

MODEL: W240-ERV-B-Z-EC

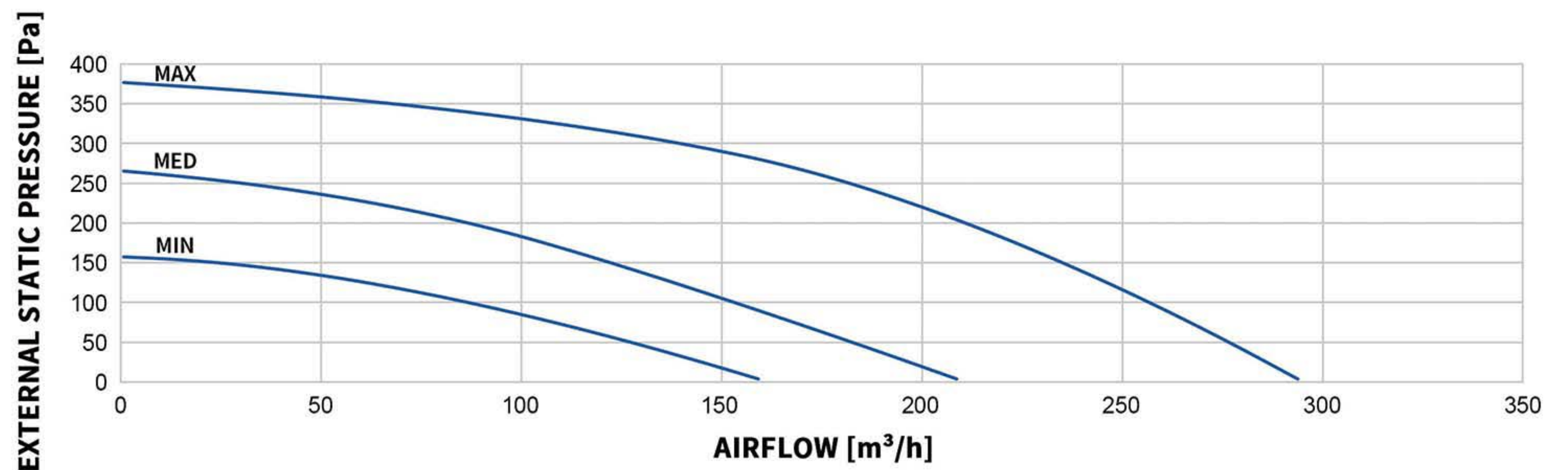
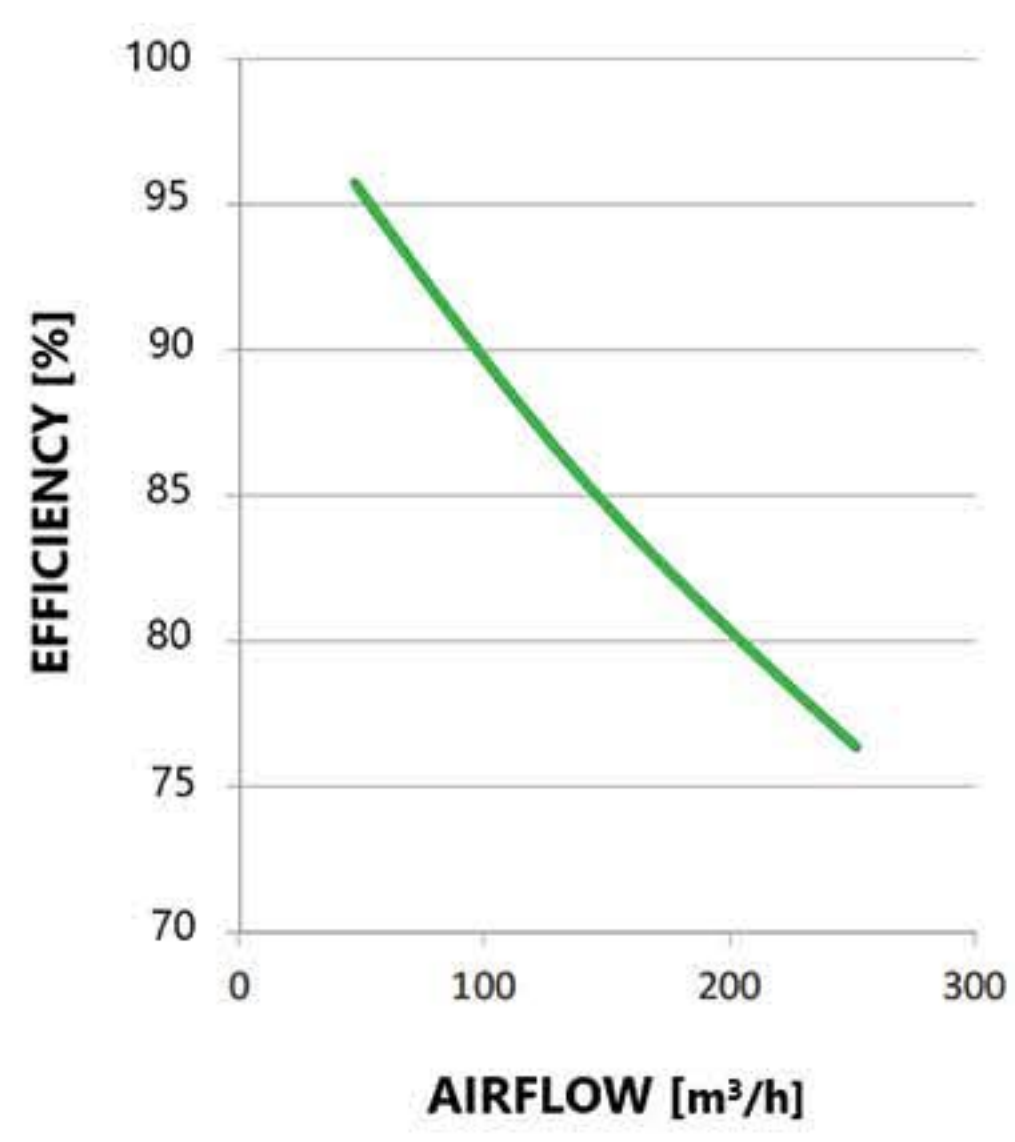

MODEL: W200-ERV-B-Z-EC

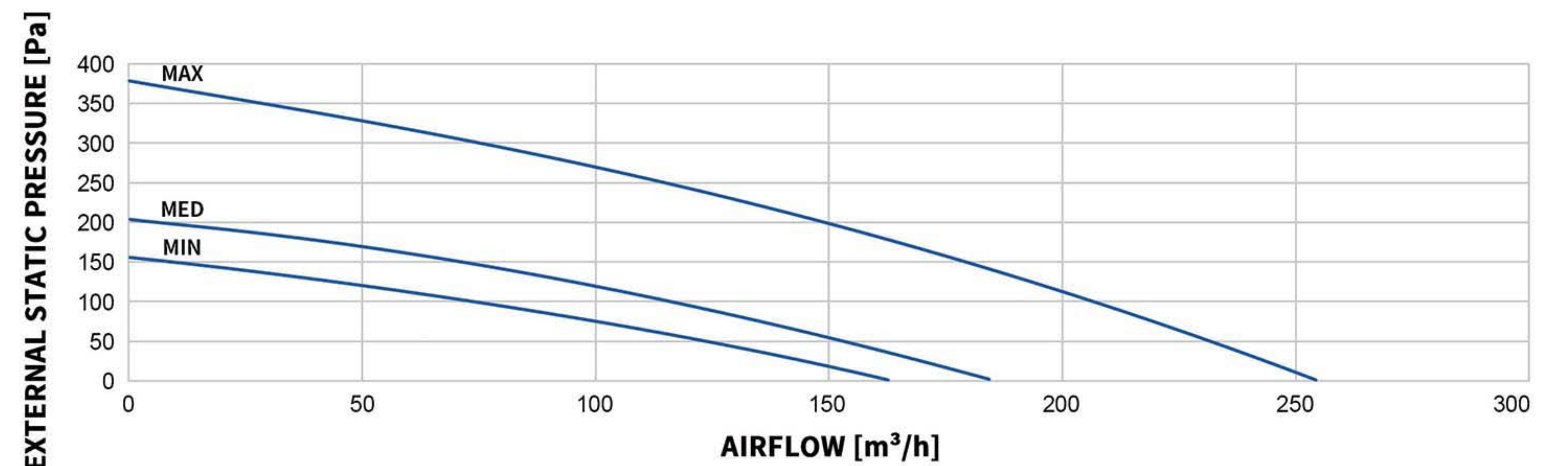
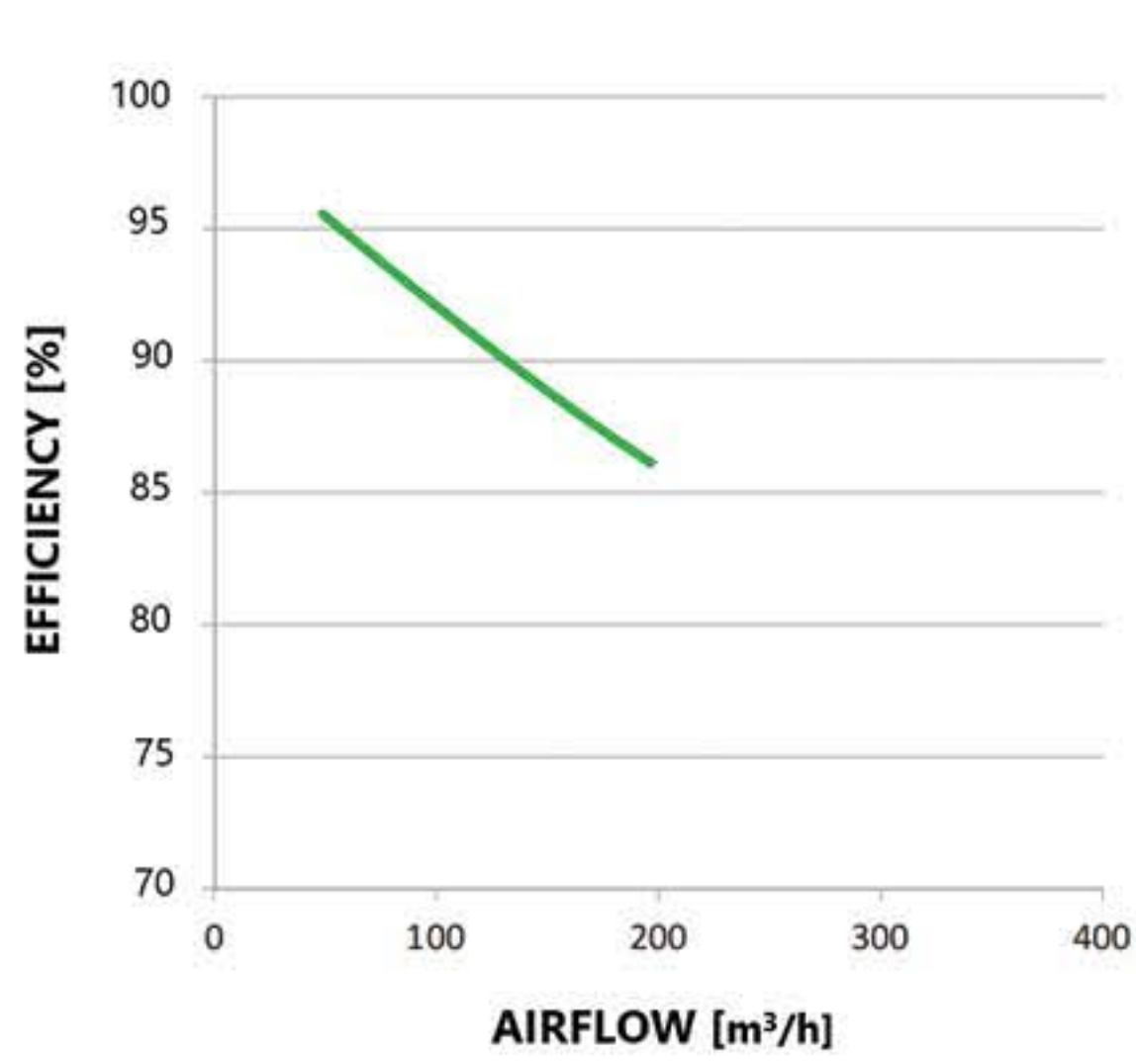

MODEL: W250-ERV-B-Z-EC

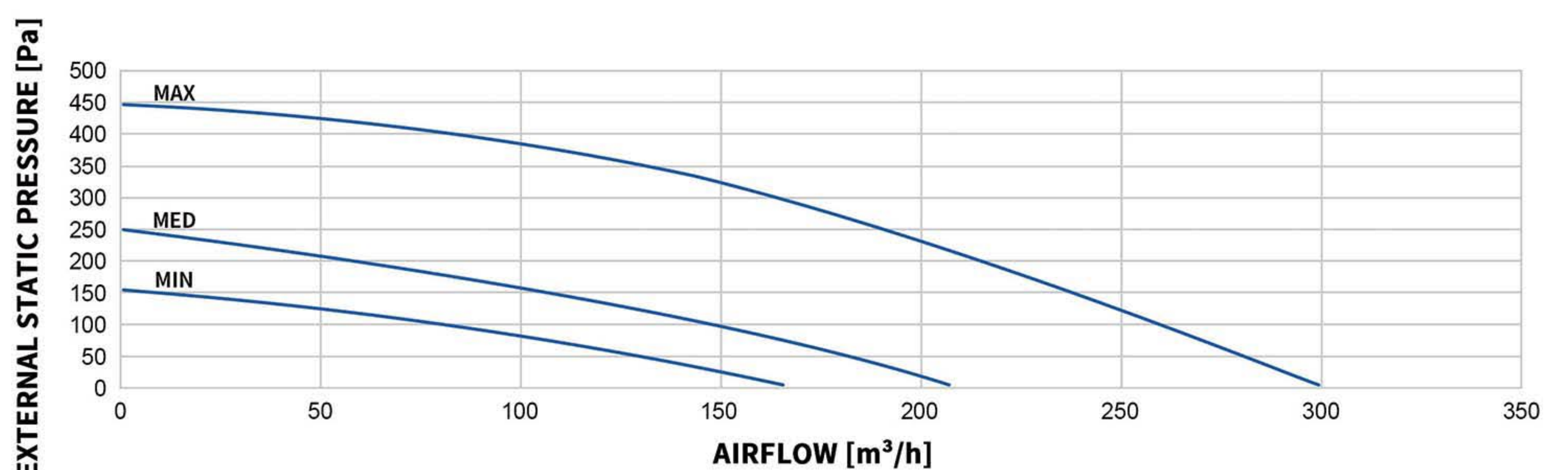
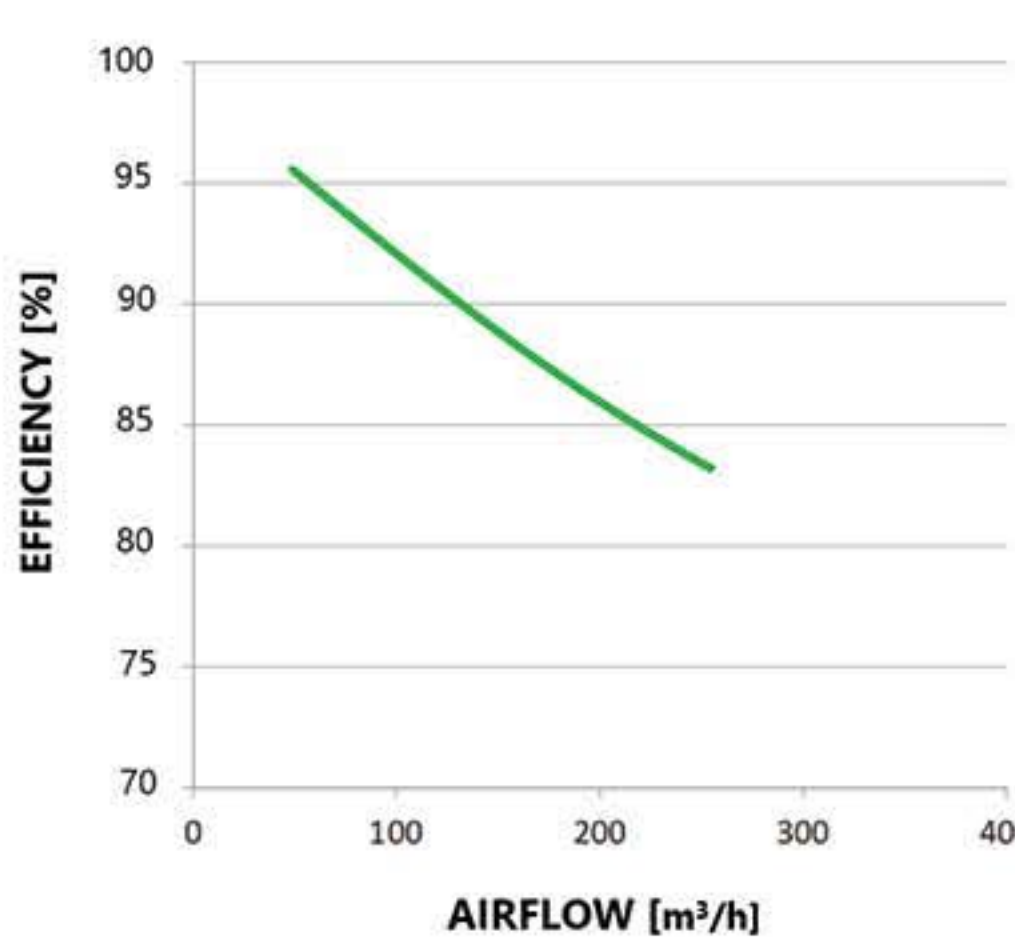

MODEL: W300-ERV-B-Z-EC

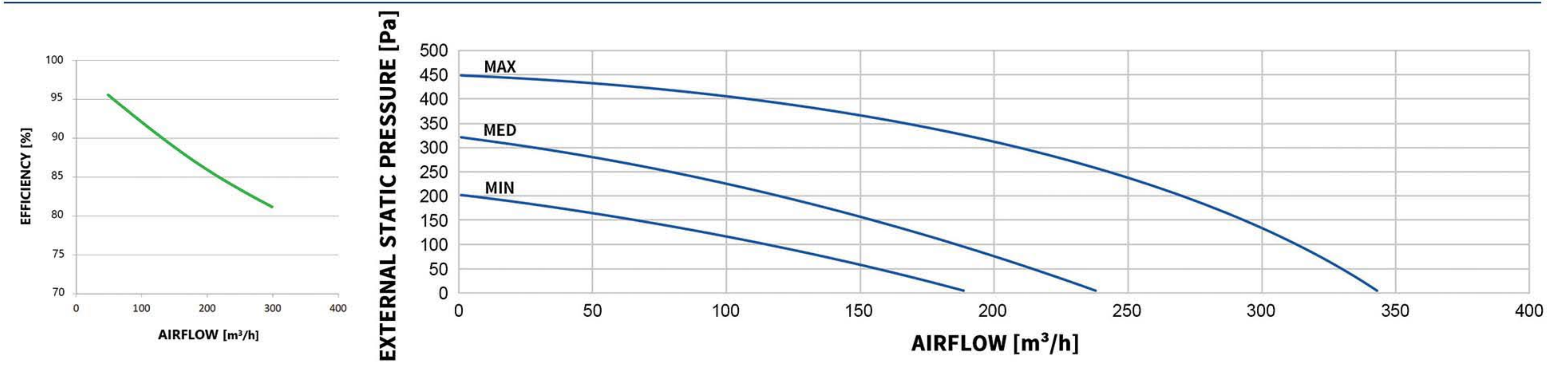

MODEL: W350-ERV-B-Z-EC

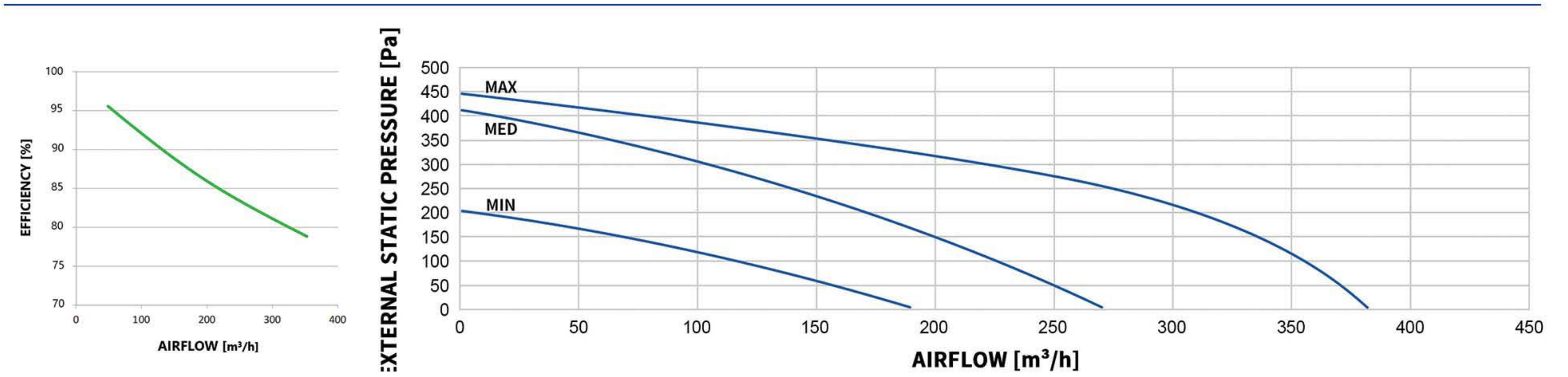

MODEL: W600-ERV-B-Z-EC

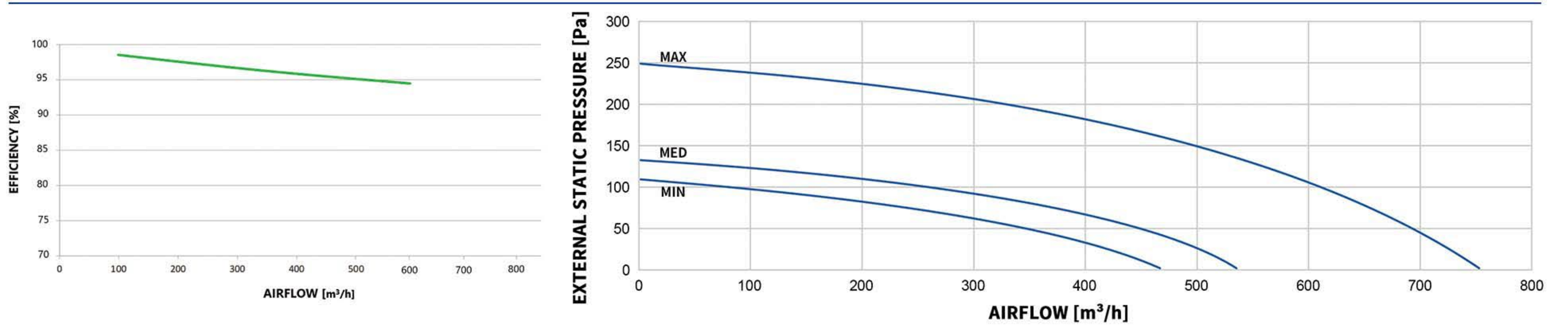

MODEL: W700-ERV-B-Z-EC

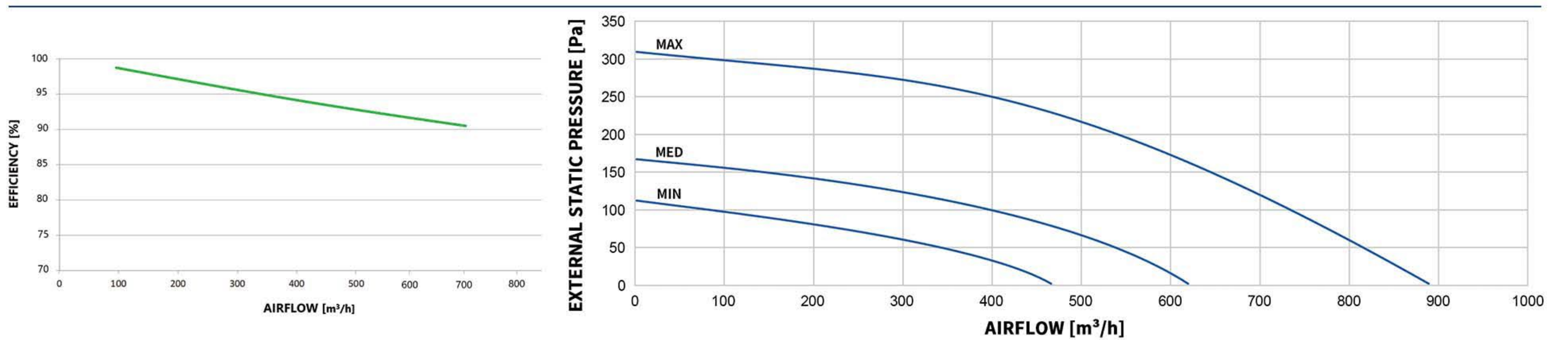

MODEL: W800-ERV-B-Z-EC

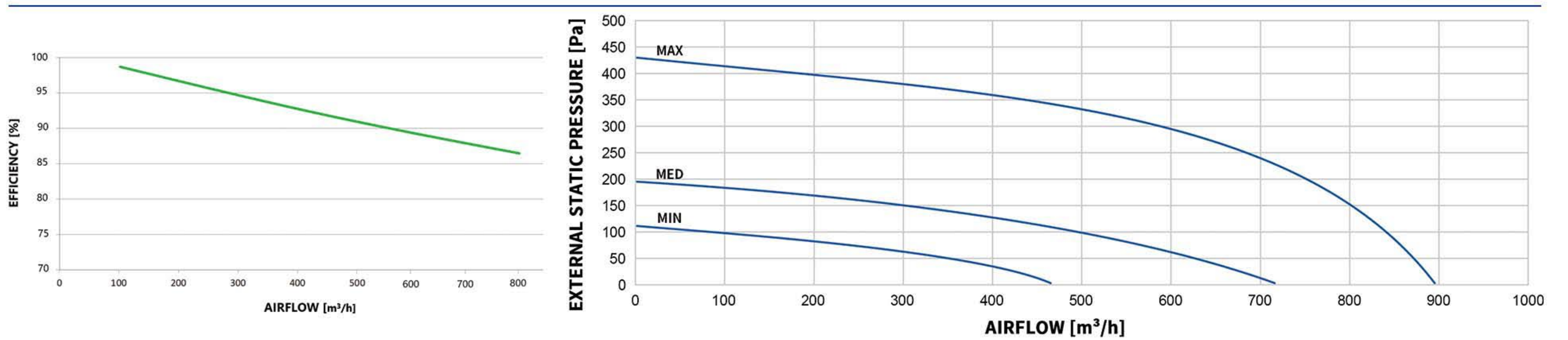



E-VIPO®